

Attrezzi per messa in fase alberi a camme

Tool for camshaft regulation



- 215 001 Bravo-Brava-Delta-Y10 Mot. Eng.1400 cc 12V
- 215 002 Lancia K anno 97 in poi 5 cil. Bravo gamma 98 Marea gamma 99 Alfa 155 Vis 2000 20 v
- 215 003 Lancia 2.4 - Alfa 3.0 V6 24 V
- 215 004 Lancia motore VIS 4 cil - Lancia K 2.4 20V
- 215 005 Lancia K 5 cil anno 96 2000 20 v
- 215 006 Bravo Brava Marea Lancia 115 cv senza variatore di fase 1800 16 v
- 215 008 Coupè Barchetta Lancia 130 Cv con variatore di fase 1800 16 v
- 215 009 Punto HGT - Motore con variatore di fase e collettore a geometria variabile 130 Cv 1800 16 v
- 215 010 Bravo Brava Marea 2000 20v
- 215 011 Alfa motore STEP A 1600 16v
- 215 012 Alfa 1.4/1.6 16v - Alfa 147 1.6 16V
- 215 013 Alfa 1.8/2.0 16V - Alfa 147 2.0 16V
- 215 014 Alfa 147 1.6 16V 105 Cv
- 215 015 Alfa 2.0 JTS
- 215 016 Alfa - Lancia 3.2cc

Cassetta attrezzi messa in fase albero a camme

Kit of tools for camshaft regulatio



- 215 021 14 motori - Motor/engine Fiat - Alfa - Lancia
Composizione: 215 001 - 002 - 003 - 004 - 005 - 006 - 008 - 009 - 010 - 011 - 012 - 013 - 014 - 015

Cassetta attrezzi messa in fase albero a camme

Kit of tools for camshaft regulatio



- 215 022 13 Motori - Fiat - Alfa - Lancia
Composizione: 215 001 - 002 - 004 - 005 - 006 - 008 - 009 - 010 - 011 - 012 - 013 - 014 - 015

Attrezzo bloccaggio albero motore per messa in fase albero a camme

Kit of tools for camshaft regulatio



- 215 025 Bravo-Brava-Delta-Y10 - Mot.Eng.1400 cc 12V

Coppia di attrezzi per bloccaggio in fase albero a camme

Twin tool holder for camshaft



- 215 026 Nuova Punto - Lancia Y - Mot.Eng.1200 cc 16v

Coppia di tastatori per bilanciamento pistoni durante la messa in fase albero a camme

Twin tool for regulation piston stroke



- 215 027 Nuova Punto - Lancia Y - Mot.Eng.1200 cc 16v

Blocchetto fissaggio puleggia distribuzione durante il serraggio della vite centrale della puleggia



- 215 02701 Mot.1400 cc 16v EVO2

Attrezzo blocco albero motore Fiat

Wrench for Block arbor Fiat motors



- 215 028 FIRE
- 215 029 Punto 188

Coppia attrezzi messa in fase alberi camme

Tools for camshaft regulation



215 030 Bravo-Brava-Stilo- Multipla 1581 16v

Kit messa in fase Motori Fiat 1.6 16V

Kit for camshaft regulation



215 031

In valigetta

Ricambi - Spare parts

213 557 Supporto PMS

215 030 Coppia attrezzo fase

215 570 Chiave tendicinghiaFil. mm 8

PER STILO E MULTIPLA BIPOWER VEDERE 215 571 E 215 57101

Confezione messa in fase alberi a camme, distribuzione e sostegno bicchierini punterie idrauliche

Tool for camshaft regulation

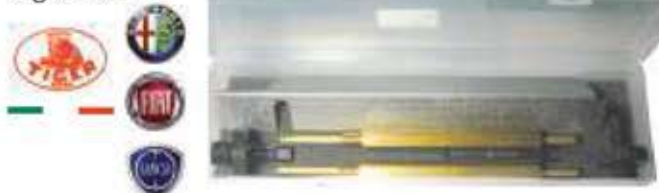

215 033 Nuova Punto - Lancia Y - Mot.Eng.1200 cc 16v

Ricambi - Spare parts

213 680 Lamiere supporto bicchierini

215 026 Pemi blocco camme

215 027 Tastatori bilancio pistoni

215 610 Chiave tendicinghia

Kit fasatura cinghia di distribuzione per motori Fiat - Alfa - Lancia 1,2 e 1,4 benzina 16V

Camschaft regulation kit



215 034

In blister

Ricambi - Spare-parts



215 026 Coppia di attrezzi bloccaggio alberi a camme



215 027 Coppia di tastatori per bilanciamento pistoni



215 02701 Attrezzo blocco puleggia distribuzione 1.4 16V

215 15801 Staffa blocco albero motore



215 610 Chiave a 2 denti per rotazione tendicinghia della distribuzione



213 680

Coppia di lamierini di sostegno delle punterie idrauliche



Dati tecnici - Informative

Per motori 1,2 16v - EVO 2 / T-jet / Abarth
Cod.motore 176B9.000 - 182B2.000 - 188A5.000

Per motori 1,4 16v - EVO 2 / T-jet / Abarth
Cod. motore 169A3.000 - 192B2.000 - 198A1.000 - 198A1.000 - 199A6.000 - 199A8.000 - 843a1.000 - 955a1.000 - 843A1.000

DIGITECH
ITALIA

Confezione per messa in fase motore

Tool for camshaft regulation



215 035 Bravo-Brava-Delta-Y10 - Mot.Eng.1400 cc 12V

Ricambi - Spare parts

215 025 Piastra blocco albero motore

215 001 Cavallotto blocco albero a camme

Attrezzo fase albero distribuzione motori Fiat FIRE

Wrench for block camshaft Fiat FIRE motors



215 038 Per motori dal n. 6800001 a 7000000

215 038 01 Per motori con n. superiore a 2533528

Kit messa in fase motori 2.2 Benzina

Kit for camshaft regulation engine 2.2 gasoline



215 039 Alfa 159 - Fiat Nuova Cromo

Ricambi - Spare-parts



215 039 01 Staffa blocco alberi a camme



215 039 02 Leva puleggia albero motore



215 039 03 Blocco alberi controrotanti

DIGITECH
ITALIA

Attrezzo blocco pompa acqua per motori Fiat 2.2 Benzina

Block pulley for water pump - Engine 2.2 gasoline



215 039 04 Alfa 159 - Fiat Nuova Cromo

Kit rimozione pompa acqua VW Tuareg 2.5 D



215 039 10 Motori BAC-BLK-BPD-BPE

Kit per lavoro su organi distribuzione motori su Fiat barchetta; Coupè



215 040 In valigetta

Ricambi - Spare-parts

215 041 particolare 1 - estraattore

215 042 particolare 2 - rotazione albero

215 043 particolare 3 - smontaggio variatore

215 044 particolare 4 - tenditore

Kit attrezzi fase SUV DR5

Engine timing tool set for DR5 - SUV



215 045 In blister

Ricambi - Spare-parts

215 045 01 Piastra blocco camme

215 045 02 Perno blocco motore

Kit per messa in fase motori F1A - F1C IVECO Daily & Ducato 2.3 - 2.8 - 3.0cc

Wrench test distribution IVECO Daily and Ducato F1A-F1C motors



215 046

In blister

Ricambi - Spare-parts

215 046 01

Asta blocco motore

215 046 02

Perni blocco camme

Kit messa in fase Alfa Mito motore 1.4 16V

Engine timing tool Alfa Mito 1.4 16V



215 047

In valigetta con fustellato

*Motori 199 A 6000 / 199 A 8000 / 955 A 8000

Composizione - Composition

215 026



Coppia di attrezzi bloccaggio alberi a camme

215 02701



Attrezzo blocca puleggia distribuzione

215 15801



Staffa blocco albero motore

215 610



Chiave rotazione tenditore

Kit messa in fase motore 1.9 JTD 16V

Engine timing tool set 1.9 JTD 16V



215 048

In valigetta con fustellato

*Alfa 159 - Fiat Nuova croma

Composizione - Composition

215 04801



Staffa blocco albero motore

215 04803



Staffa blocco volano

215 07600



Perno blocco albero a camme

Kit messa in fase Fiat Croma - Alfa 159 1.8 16V

Kit canshaft regulation Fiat Croma-Alfa 159 1.8 16V



215 491
Con riferimento
marcato al laser
per facilitarne
l'utilizzo

215 049

Kit in valigetta

Ricambi - Spare-parts

215 049 01



Attrezzo ferma volano

215 049 02



Staffa blocco alberi a camme

215 491



Attrezzi blocco pulegge
alberi a camme

DIGITECH
ITALIA

Settore graduato messa in fase motore

Jig for ignition timing



215 050 Universale - Diam. 130 mm

215 051 Universale - Diam. 240 mm

Spina per messa in fase albero motore

Retainer for flywheel



215 053 Citroen 1.9 D

Perni per messa in fase puleggia iniezione

Nuts for retain injection pump



215 054 Citroen 1.9 D

Attrezzo mantenimento P.M.S. sul 1° cil.

Retainer for T.D.C. on first cylinder



215 061 Mot. Fiat 1697 D-1929 D

215 062 Mot. 1910 D TD - 1910 JTD - 2387 TD-JTD

Kit messa in fase cinghia distribuzione Multiair 1.4

Timing tool for Fiat Multiair 1.4



215 068

In valigetta

Composizione - Composition

215 06801



Piastra blocco albero a camme

215 15801



Staffa albero motore

Dati tecnici - Informative

Motori:

198A7000 - 940A2000 - 955A2000 - 955A6000 - 955A7000 - 955A8000

Kit messa in fase cinghia distribuzione Twin Air

Timing tool for Twin Air



215 069

In valigetta

Composizione - Composition

215 06901



Piastra blocco albero a camme

215 06902

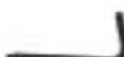

Perno blocco albero motore

215 06903



Perno fasatura puleggia

Dati tecnici - Informative

Motori:

312A2000 fino al 2012:

Alfa Romeo Mito / Fiat Panda / Fiat Punto / Lancia Y - 312A4000

Confezione per messa in fase motore

Tool for camshaft regulation



215 070 Motori DIESEL 1697D - TD 1929 D - TD 1910D
- TD 1910 JTD - 2387 TD JTD

Composizione - Composition

- 215 061** Mot. Fiat 1697 D-1929 D
- 215 062** Mot. 1910 D TD - 1910 JTD - 2387 TD-JTD
- 215 071** Mot. Fiat 1697 D-TD 43.5°
- 215 072** Mot. Fiat 1929 D 42.5°
- 215 073** Mot. Fiat 1929 TD 41.5°

Note:



Kit fasatura Alfa Romeo Giulietta e 159

Engine timing tool Alfa Giulietta & 159



215 074 Kit 5 pz. In valigetta

Per Giulietta quadrifoglio verde 1700i - 16v - Turbo
Per 159 Tbi - 16v - Turbo - Lancia Delta 1.7 TBI 16V.
Turbo

Composizione - Composition

- 215 07401** Staffa blocco alberi a camme
- 215 07402** Staffa blocco alberi a camme
- 215 04801** Staffa blocco albero motore
- 215 04803** Staffa blocco volano 159
- 215 07655** Staffa blocco volano Giulietta

Kit fasatura motori Multijet Fiat 1.3

Tool for camshaft regulation Multijet 1.3



215 075

Kit in valigetta

Composizione - Composition

- 215 07501  Coppia blocco alberi camme
- 215 07502  Blocco albero motore perno m10
- 215 07503  Tendicinghia
- 215 07504  Blocco volano
- 215 07505  Blocco volano perno Ø 8
- 215 13903  Blocco volano perno Ø 6

Note:

DIGITECH
ITALIA

Kit fasatura motori Multijet Fiat 1.3

Tool for camshaft regulation Multijet 1.3



215 07500



Kit in valigetta con fustellato

Composizione - Composition

- 215 07501  Coppia blocco alberi camme
- 215 07502  Blocco albero motore perno m10
- 215 07503  Tendicinghia
- 215 07504  Blocco volano
- 215 07505  Blocco volano perno Ø 8
- 215 13903  Blocco volano perno Ø 6

Adattatori opzionali - Optional adaptor

Kit integrativo da abbinare al 215 07500 per poterlo utilizzare per motori Multijet 1.3 e 1.9



215 07611

Kit in sacchetto

Composizione - Composition

- 215 062  Attrezzo mantenimento PMS
- 215 07601  Blocco albero a camme

Chiave speciale sottile per contrasto puleggia albero motore 1.3 Multijet

1.3 Multijet crankshaft pulley wrench



215 07510

occa mm 54

Kit fasatura motori Multijet Fiat 1.9

Tool for camshaft regulation Multijet 1.9



215 076

Kit in valigetta con fustellato

Composizione - Composition

215 062  Attrezzo mantenimento PMS

215 07504  Blocco volano

215 07601  Blocco albero a camme

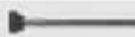
215 13903  Blocco volano perno Ø 6

Kit messa in fase motori 1.3 e 1.9cc Multijet

Tool for camshaft regulation Multijet 1.9



215 07610

In valigetta

Ricambi - Spare-parts

215 062  Staffa blocco albero motore

215 075 01  Coppia blocco alberi a camme

215 075 02  Blocco albero motore (perno mm10)

215 075 03  Tendicinghia

215 075 04  Blocco volano

215 075 05  Perno Ø8 blocco volano

215 076 01  Coppia perni albero a camme

215 139 03  Perno Ø6 blocco volano

Kit messa in fase motori 1.6 cc Multijet

Engine timing tool set 1.6 Multijet



215 07650

In valigetta

Ricambi - Spare-parts

215 048 01  Staffa blocco albero motore

215 076 00  Perno blocco albero a camme

215 076 55  Staffa blocco volano

DIGITECH
ITALIA

Adattatori opzionali per nostri art: 215 075 & 215 076 10 da utilizzare su versioni particolari di motori 1.3 Multijet



215 076 56



Perno blocco volano
mm 9 x100

215 076 57

Perno mm 9



Staffa blocco albero motore

Kit messa in fase motori VW Polo 1.2

Timing tools VW - Polo 1.2



215 077 3 Cilindri / 12 Valvole in blister

Ricambi - Spare-parts



215 077 01 Coppia attrezzi alberi a camme



215 077 02 Perno blocco albero motore

Kit messa in fase motori VW Polo 1.2 3 cilindri / 6,12 valvole

Timing tools VW - Polo 1.2



215 078 3 Cilindri / 6 - 12 Valvole - Kit in valigetta

Dati tecnici - Informative

Motori:

AWY - AZY - BMD - BME

Attrezzo fasatura pompe iniezione

Tool for injection pump regulation



215 079 Pompe Lucas su Kangoo, Doblò e Mercedes

Attrezzo mantenimento fase pompa iniezione

Tool for checking the delivery injection pump



215 080 Mercedes 190 D-C 220 D

Chiave Torx con foro passante per variatore di fase Mercedes:

Dal 2000 per modelli turbo benzina

Dal 2005 per modelli SLK - CLK

Torx wrench phase shifter



215 08010 Bussola Torx con attacco 3/4"

Perni blocco alberi a camme motori Mercedes Classe A



215 081

Blocco albero a canne

Clamp for stroke checking



215 082 BMW 316 - 318 -Z3 - 750 - 850 - Motori 16 4E 2 (E30-E36) / 18 4E 2 (E28-E36) / 19 4E 2 (M43) - 50 12A (M70)/56 12 1 (S70)/54 12 1 - 54 12 2 (M73)

Blocco albero a canne

Clamp for stroke checking



215 083 BMW 318 TDS - 325 TDS- 525 TD-TDS - 725 TDS -
Motori 17 4T 1 (E36) / 25 6T 1 (E39-E34-E38)

215 084 BMW TD 524 vecchio modello

Kit fasatura motore BMW tutti i modelli benzina doppio albero a camme con testata singola

Kit for stroke cheking BMW duoble camshaft



215 085 BMW 318-320-323-328-520-523-525-528-728-Z3 -
Motori 18 4S 1 / 19 4S 1 / 20 6S 2 / 25 6S 1 / 25 6S
2 / 20 6S 3 / 25 6S 3 / 28 6S 1 / 20 6S 4 / 25 6S 4 /
28 6S 4 / 28 6S 2.

Attrezzo fasatura contralberi motore BMW 318 IS



215 08501

Kit in valigetta per fasatura motore BMW

Kit for phase motor BMW



215 085 10 BMW 316-318-320-323-325-520-523-525-528-725-
728-Z3 (Per motori vedi 215 082 e 215 085)

Kit messa in fase pompa iniezione e alberi controrotanti per BMW N 47 (utilizzabile solo in abbinamento a nostro 21508515)

Timing tool for BMW N 47



215 085 12

In blister

Kit messa in fase motori BMW 2.0 N47 - N47s (DV20A / B)

Engine timing tool set 2.0 BMW

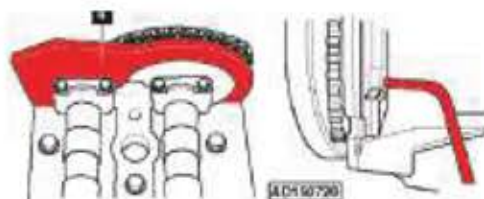

215 08515

Pz 5

In valigetta

Contiene



Perno di fasatura volano



Chiave rotazione puleggia

215 08516



Piastra blocco alberi a camme

215 08517



Chiave rotazione motore

215 08750



Attrezzo smontaggio pompa carburante

Kit messa in fase motori BMW 2.0

N47 Engine timing tool set 2.0 BMW



215 085 19 In valigetta

Ricambi - Spare-parts

215 085 13  Fase pompa iniezione

215 085 14  Fase alberi controrotanti

215 085 16  Piastra blocco alberi a camme

215 085 17  Chiave rotazione motore

215 086 01  Perno blocco albero motore

Per modelli:

118d. E81-87 (06-09) / 120d. E81-82-87 (06-09)

123d. E81-82-87 (07-09) / 318d. E90-91 (07-09)

320d. E90-91-92 (05-09) / 520d. E60-61 (06-08)

x3 2.0d. E8 (07-09)

Adattatori opzionali - Optional adaptor

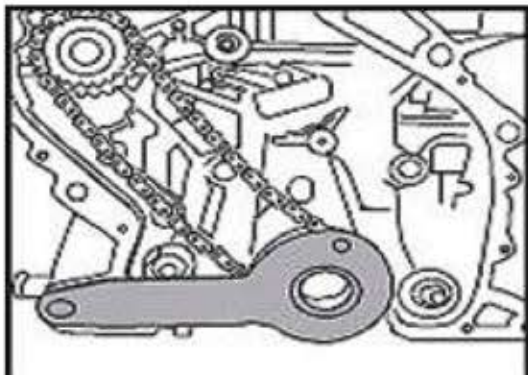

215 08518 Staffa di fissaggio motore per Mini
Modello: N 47 C 16 A BMW

Kit messa in fase motori Bmw M60 & M62

Kit for Bmw engine models M60 & M62



215 08520 In valigetta

Kit di supporto per la sincronizzazione del motore per motori BMW 1.2, 1.5, 2.0 a benzina e diesel

Crankshaft turnibg / holding kit for Bmw / Miny



215 08522 In valigetta

Dati tecnici - Informative

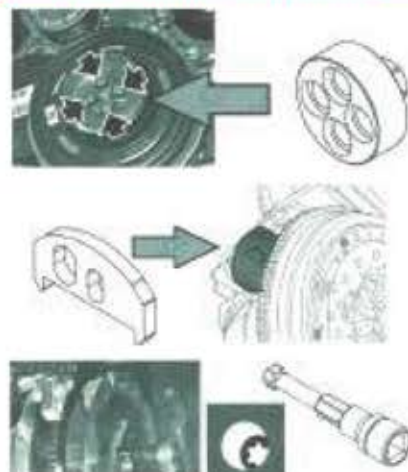

OEM: 11 6 480, 11 9 811, 11 9 265, 11 4 180

Codici motore: B37, B38, B47, B48 (1,2 L, 1,5 L, 2,0 L)

Applicazioni: BMW 1,2,3,5 Series (2014-2017), 4, 7 Series (2015-2017), X1, X3, X4 Series (2014-2017), X5 Series (2015-2017), Mini Clubman (2014-2017), Mini Hatch (2015-2017), Mini cabriolet (2016-2017)

Staffa riscontro fase motori BMW M47 - M57

Wrench test distribution BMW M47 - M57 motors



215 086 Kit completo x BMW 320d/330d/530d/730d - Motori 20 4d 1 (M47) / 30 6d 1 (M57)

Ricambi - Spare-parts

215 08601 Perno blocco volano

Kit 8 pz. estrattori pompa iniettore

Kit 8 pcs tool for injection pump



215 08700 In valigetta

Composizione - Composition

215 08710 Estrattore per BMW M47 / M57 318D/E46, 320D/TD 46, 330D/E46, 525D/E39, 515D/E60/E61, 530D/E39, 730D/E38, 530D+535D/E60/E61, X5 3.0D/E53



215 08750 Estrattore per pompa i CP4 BMW serie 1/N47, N47S E60, E81, E83, E87, E90



215 088 Estrattore per BMW M41 / M51 Serie 3/E36, Serie 5/E34, Serie 7/E38



215 095 Estrattore spine staffa guida catena distribuzione - Mercedes



215 08711 Estrattore BMW M47, Rover 75, LR frelander, Vauxhall, Opel omega B



Estrattore pompa iniezione BMW M47 - M57

Tool for injection pump BMW M47 - M57



215 087 10 Kit completo

Composizione - Composition

215 087 Estrattore/Puller/Extractor

215 087 01 Ghiera di supporto estrattore - 42x1.5

215 087 02 Ghiera di supporto estrattore - 40x1.5

Estrattore pompa iniezione CP4

Tool for injection pump CP4



215 08750 BMW serie 1 n 47 I n blister

Estrattore per pompa iniezione BMW con ingranaggio avente filetto maschio

Tool for injection pump BMW



215 088

Kit registro fasatura motori BMW M52 - M54 - M56



215 089 Kit Completo - Motori 20 6S 4 / 25 6S 4 / 28 6S 4 / 28 6S 2

215 089 01 Piastra alluminio per allineamento pulegge

215 089 02 Piastra teflon allineamento ruota fonica.

Kit attrezzi per fasatura distribuzione motori BMW N42 - N46 - N46T

Timing tool set for Professional Engine Repair



215 08910 In valigetta

Modelli Vetture BMW:

E87	118i / 120i - Motore N46
E46	316i / 316ti / 318i / 318ti - Motore N42
E46	316i/316ti/318ti- Motore N42
E90 / E91	318i / 320i - Motore N46
E85	Z4 , 2,0l - Motore N46

Kit registro fasatura motori benzina) Bmw N62 / N73

BMW input / output camshaft alignment tool set



215 08920 In valigetta

Kit registro fasatura motori benzina Bmw N52

Engine timing tool set for repair BMW N52



215 08930 In valigetta

Kit messa in fase Bmw N51 / N52 / N53 / N54

Engine timing tool set for N51 / N52 / N53 / N54



215 08940 In valigetta

Per modelli:

128i - E82 (07-08), 130i - E81/E87 (05-08), 135iS. E82 (07-08), 323i - E90/91/92/93 (04-08), 325i / xi - 330i / xi - 335i / xi - 523i / Li - E60/61 (04-08) X3 - 2.5 / 3.0 E83 (06-08), Li / 525i / xi - E60/61 (06-08), 630i - E60/61 (04-08), 528i / Li / xi - E60/61 (06-08), 530i / Li / xi - E60/61 - (05/08), 535i / xi - E63/64 (04-08), 730i / Li - E65/66 (04-08), X5 3.0 - E70 (06-08), Z4 2.5 / 3.0 - E85/86 (05-08) - 328i E90/91/92/93 (04-08) xi

Kit messa in fase Bmw N40 / N45 (T)

Kit messa in fase Bmw N40 / N45 (T)



215 08950 In valigetta

Per modelli:

1 serie 116 E81 / E87 - 3 serie 316i E46 / E90 - 316 CI E46 316 TI E46

Kit messa in fase motori BMW 1.5 / 2.0 (N43)

BMW (N43) Petrol 1.6 - 2.0 Timing tool kit



215 08960 Kit in valigetta

Dati tecnici - Informative

Modelli:

1 SERIE E81 - 82 - 87 - 88 (06-12)
3 SERIE E90 - 91 - 92 - 93 (06-12)
5 SERIE E60 - 61 (07-10)

Codici motori:

N43 B16A/AA - N43 B20A - N43 B20AA
N43 B20AY - N43 B20KO - N43 B20UO

Kit per estrazione pompa iniezione Per Kia e Hyundai

Kia injection pump extraction kit



215 090 Kit Pz.4 In valigetta

Ricambi - Spare parts

215 09010



Estrattore 30 x 1,5 per pompa iniezione Kia

215 09011



Piastra per estrazione pompa iniezione Kia
per motori "U" - D4FA (DSL) 1,5L

215 09012



Piastra per estrazione pompa iniezione Kia
Codici motori:
D 1,1 TCi-U2, D 1,4 TCi-U2, D 1,6 TCi-U2, D 1,7 TCi-U2
1,6 TCi-U2
1,4 CRDi-U2, 1,6 CRDi-U2
Veicoli:
Kia Karens, Ce3ed, Optima, Rio, Soul, Sportage, Venga
Hyundai Matrix, Getz, i30

215 09020



Attrezzo estrazione pompa iniezione CP4
Per Hyundai Santa Fe / Kia Sportage

Staffa ritegno puleggia distribuzione per messa in fase



215 091 Audi D

Staffa ritegno puleggia distribuzione per messa in fase



215 092 Fiesta D

Estrattore spine staffa guida-catena distribuzione

Toll for crunshaft pins Mercedes



215 095 Estrattore mm 90

Estrattore puleggia pompa diesel motori VAG

VAG - Diesel pump sprocket puller



215 098

Dati tecnici - Informative

Per motori: 1.4L, 1.6L, 2.0L - TDi - OEM: T10489
VW; Golf dal 2013
Audi A3 dal 2013
Audi dal 2005
Skoda; Rapid dal 2012 - Octavia dal 2013 - Fabia dal 2014 -
Superb dal 2015 - Kodiaq dal 2016
Seat; Ibiza dal 2008 - Alhambra dal 2011 - Leon dal 2013

Perno di riscontro fase precamera

Pin for stroke checking



215 105 Mot. 1930 D

Perno fase Ford C-Max 1.6



215 106

Kit fasatura Ford 2.0 EcoBlue TDCi

Engine timing tool Ford 2.0 EcoBlue TDCi

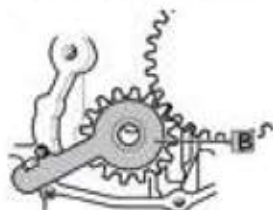
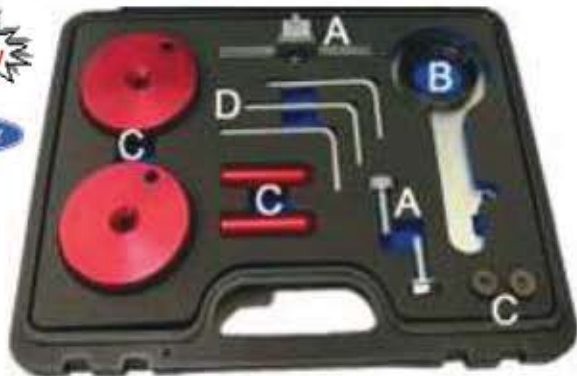

215 107

In valigetta

Dati tecnici - Informative

- A: Attrezzo bloccaggio volano
- B: Attrezzo bloccaggio albero motore
- C: Attrezzo installazione cinghia

Per Ford Transit, Transit Custom
Motore N°: YLSF, YMFS, YNFS, YLF6, YMF6, YLR6,
YMR6, YNR6
oem n° 303-1643, 303-1637, 303-1650

Attrezzo per smontaggio e rimontaggio pompa VP per motori Ford Duratorq 2.0, 2.2 e 2.4

Set for assembly / disassembly Vp pump on engine Ford Duratorq 2.0, 2.2, 2.4



215 108



Attrezzo smontaggio pompa iniezione dall'ingranaggio di comando

Tool for dismounting Injection pump



215 110

Ford 1600 D



Staffa ritegno puleggia distribuzione per messa in fase

Timing tool for camshaft regulation



215 112

Alfa 90 alfetta Motronic



Chiave ghiera fissaggio ingranaggio distribuzione

Wrench for distribution nut



215 113

Alfa 90 Alfetta Motronic

55 mm



Chiave per smontaggio variatore di fase albero distribuzione



215 114

Alfa 90 Alfetta Motronic

58 x 52 x 4,5



Kit fasatura Chrysler, Jeep, Dodge 2.8 D

Engine timing tool set Chrysler 2.8D



215 116 Pz.3 In valigetta

Dati tecnici - Informative

A: Attrezzo bloccaggio albero motore
B: Attrezzo bloccaggio alberi a camme
Jeep Cherokee, Chrysler, Grand Voyager (2008 - 2011)
Codici motore: VM64C / ENS / ENS (51C) / 49C / 50C /
ENS VM10D / ENS VM11D

Kit messa in fase motori Chrysler 2.5 - 2.8

Kit for camshaft regulation Chrysler motors 2.5 - 2.8



215 117 Kit completo Voyager - Cherokee - Pz 4

Ricambi - Spare-parts

- 215 117 01 Spina singola
- 215 117 02 Spina singola
- 215 117 03 Spina singola
- 215 117 04 Spina singola

DIGITECH
ITALIA

Kit fasatura motori Chrysler, Jeep, Ldv:2,5-2,8CRD diesel

Timing tool Chrysler 2,5 - 2,8 CRD diesel



215 11700 In valigetta

Dati tecnici - Informative

Modelli:

Chrysler Voyager & Grand Voyager dal 2001 al 2008
Jeep Cherokee dal 2001 al 2008
LDV maxis dal 2005 al 2009

Codici motori:

2,5 CRD: R2516C - R2516K - R2516L
2,8 CRD: R2816C5.05A - R2816K4

Estrattore per puleggia ventola

Puller for fan coil pulley



215 118 Alfa 164 2.5 Td

Kit per la messa in fase motori Citroen - Peugeot

Kit camshaft regulation engine Citroen Peugeot



215 119 In valigetta

CITROEN: AX - Berlingo - BX - C5 - C15 - C25 - Dispart - Evasion - Jumper - Jumpi - Relay - Saxo - Synergie - Visa - Xara - Xantia - Xm - XJR - ZX

PEUGEOT: 106 - 205 - 306 - 405 - 406 - 605 - 806 - J5 - Boxer - Expert - Partner - Solara - Talbot Express - Talbot Horizon

Kit messa in fase motori Citroen - Peugeot

Engine timing tool set - Citroen - Peugeot



215 119 01 Motori 1.4 - 1.6 HDI - 2.0 16V Bz

Confezione per messa in fase motore

Tool for camshaft regulation



Particolare Spina mm 6



215 120

In valigetta

Ricambi - Spare-parts

- 215 121 Attrezzo fermo / Pin / Eje 7.5 - 8 mm
- 215 121 01 Attrezzo fermo / Pin / Eje 6 mm
- 215 122 Coppia spine / Twin pins / Doble eje 6.6 mm
- 215 123 Coppia viti /Twin bolts /Doble tuercas 6x1 - 55 mm
- 215 124 Tre viti / Tree bolts / Tres tuercas 8x1.25 - 50 mm

Kit fasatura motori Benzina Peugeot - Citroen 1,0 - 1,2 VTi

Timing tool kit for Peugeot - Citroen petrol engine



215 12010

In valigetta

Modelli:

Peugeot 208 1.0 VTi - EBO (ZMZ) / 1.2 VTi EB2 (HMZ)
 Citroen C 3 1.0 VTi - EBO (ZMZ) / 1.2 VTi EB2 (HMZ)
 Per codici motore: EBO (ZMZ), EB2 (HMZ)
 Per; bloccaggio del volano, OEM 0109-2B
 Per; regolazione alberi a camme, OEM 0109-2A

Kit messa in fase motori Audi - Ford - Vw - Volvo e motori Zetec



215 125 Questa composizione sostituisce quella precedente

Ricambi - Spare-parts

- 215 100 Spina Golf Diesel Ø 15.4
- 215 101 Spina Ford Diesel Ø 6
- 215 102 Spina Ford Zetec 1.2 - 1.4 - 1.6 - Ø 5
- 215 104 Spina Ford 1.8 - 2.0 16V
- 215 126 Staffa di fermo albero a camme
- 215 127 Coppia di spine Ø 6
- 215 128 Spina Ø 8.25
- 215 129 Spina Ø 9.5
- 215 130 Spina Ø 12.7
- 215 131 01 Spina Ford blocco - volano Ø 9
- 215 131 02 Spina Ford blocco - volano Ø 13
- 215 133 Staffa di fermo albero a camme
- 510 414 Spessimetri 0.05 - 1.00 - 20 Lame

Coppia di spine per blocco volano motori Ford 1.4 TDCi - 2.0 - 2.4

Pin couple for fly-wheel block engine Ford

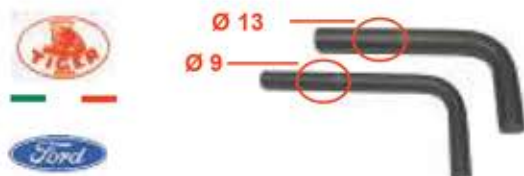

215 131 Spina Ø 9 + Spina Ø 13

Ricambi - Spare-parts

215 131 01 Spina singola Ø 9

215 131 02 Spina singola Ø 13

Kit messa in fase motori Ford 1.4 - 2.0 - 2.4

Engine timing tool set Ford 1.4 - 2.0 - 2.4



215 132 In valigetta

Attrezzi fasatura motori Ford

Timing tool set for Ford



215 13310 In blister Ford Fiesta / Fusion 1.2 - 1.4 - 1.6
Ford Focus / C-Max 1.4 - 1.6



Kit fasatura Ford Focus e C-Max

Ford Focus e C-Max engine timing kit

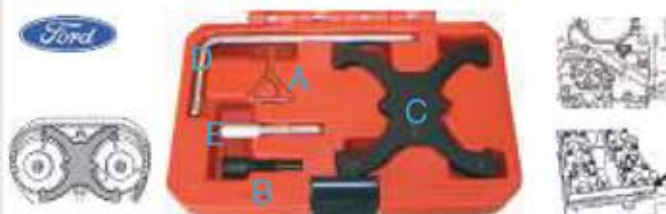

215 13320 In valigetta

Dati tecnici - Informative

- A: Spina blocco tendicinghia
- B: Spina blocco albero motore
- C: Piastra blocco pulegge alberi a camme
- D: Blocco volano
- E: Perno blocco alberi a camme e albero motore

Modelli:

1.6 Ti-VCT con codice motore HXDA (03-07)

2.0 TDCi con codice motore G6DA - GDB - G6DC (03-07)

Attrezzo allineamento albero motore Ford

Ford Focus e C-Max engine timing tools kit

Adattatore opzionale per:
215 13320 e 215 13322



215 13321 In blister

Modelli:

Ford 1.6 Ecoboost

OEM: - 303 - 1550 - 1552 e Volvo 9997431

Note:

Kit fasatura Ford Focus - C-Max 1.6 VVT

Tool kit Ford 1.6 VVT engine timing kit

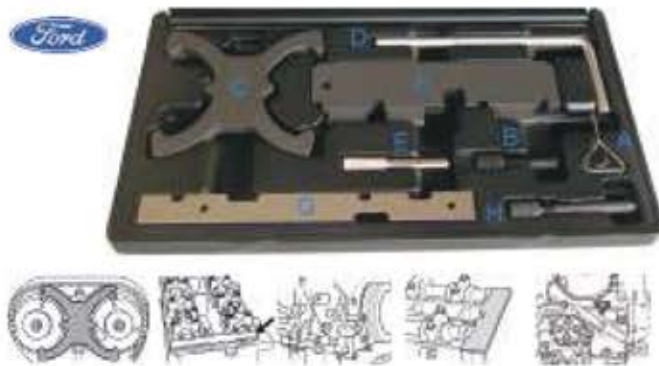

215 13322

In valigetta

Dati tecnici - Informative

- A: Spina blocco tendicinghia
- B: Spina blocco albero motore
- C: Piastra blocco pulegge alberi a camme
- D: Blocco volano
- E: Perno blocco alberi a camme e albero motore
- F: Piastra blocco camme
- G: Piastra blocco camme
- H: Perno blocco albero motore

Modelli:

Ford B-Max - C-Max + Grand C Max - Fiesta - Focus - Galaxy - Kuga - Mondeo - S Max - Tourneo Connect - Transit connect -

Codici motori:

JQMA - JQMB - JTMA - JQJA - JQDA - JQDB - JTDA - JTDB - JQDA - JQDB - PNDA - XTDA - MUDA - JTJA - JTWA - JTWB - JTBA - JTBB - KGBA - JQJA -

Ricambi - Spare parts

Piastra per blocco camme

Camshaft setting Bar

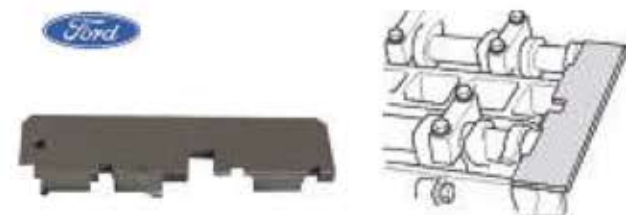

215 13323

In Blister

Modelli:

Ford 1.6 Ecoboost

OEM: 303 - 1552

Kit fasatura Ford 1.0 Turbo, 3 cilindri - Ecoboost Scti

Tool kit 1.0 Ecoboost 3 cylinders petrol engine

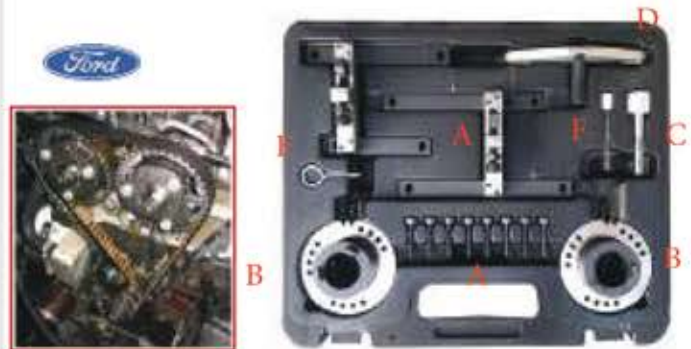

215 13330

In valigetta

Dati tecnici - Informative

- A: Set bloccaggio alberi a camme
- B: Set regolazione VVT camme
- C: Perno blocco albero motore
- D: Attrezzo bloccaggio volano
- E: Perno blocco tenditore
- F: Perno blocco puleggia albero motore

Modelli:

Ford Fiesta, Ecosport, B-Max, Transit courier, Focus, Transit connect, C-Max, Tourneo connect, Grand C.Max

Codici motori:

M1DA, P4JA, XMJA, M1JA, P4JB, XMJB, M2DA, SFJA, M2GA, SFJB

Applicazioni: Motori benzina ecoboost 1.0, 3 cilindri con cinghia a bagno d'olio

Kit fasatura Ford 2.0 Ecoboost

Engine timing tool set



215 13350

In valigetta

Dati tecnici - Informative

Modelli:

Ford Galaxy - Mondeo - S Max dal 2010
Ford Focus dal 2011

Codici motori:

TNWA, TNBA, TPWA, MGDA, XQDA

Codici compatibili e utilizzabili come OEM:

303-748 / 999 7406 / 21-259 / 999 7125 / 9997152 / 303-1504 / 303-1565 / 303-1521

Kit messa in fase motori Ford Duratorq Diesel 2.0 - 2.2 - 2.4

Tool kit Diesel 2.0 - 2.2 - 2.4 TDDI - TDCI



215 134

In valigetta

Confezione messa in fase motori: Fiat 4HV; Peugeot P22DTE (4HV - 4HU) 2.2 TDCi - HDi

Timing tool Ford 2.2 TDCi Transit



215 134 10

In blister

Ricambi - Spare-parts

- 215 131 02 Perno blocco volano motore
- 215 139 03 Perno blocco pulegge camme (2Pz)
- 215 155 03 Perno blocco tenditore catena
- 215 134 11 Staffa blocco motore

Kit fasatura motori Ford 2.2 TDCi Transit

Timing tool Ford 2.2 TDCi transit



215 13415

In valigetta

Codici OEM:

0188h - 21-251 - 303-689 - 303-1587 - 18609650000

Adattatori opzionali - Optional

Leva blocco puleggia albero motore Diesel Per Ford Mondeo e Transit 2.0, 2.2, 2.4, 3.2



215 13416

Leva

Kit messa in fase cinghia distribuzione motore Ford 1.4 TDCi / 1.6 TDCi e Citroen / Peugeot 1.4 HDI Mini

Timing tool for 1.4 & 1.6 TDCi & Peugeot 1.4 HDI

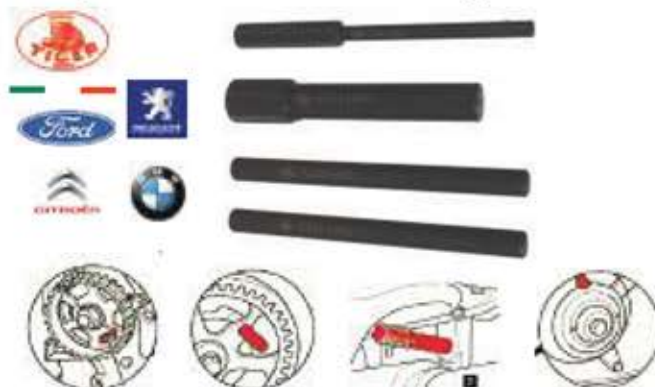

215 134 20

In blister

Ricambi - Spare-parts

- 215 13421 Perno albero motore
- 215 13422 Perni puleggia camme e pompa gasolio
- 215 13423 Perno ghiera posteriore puleggia

Cod Motori;

W16D16 (9HZ) / W16D16UO o 9HZ / 9HX / 9HY (DV6TED4)
Mini Clubman, R55 / R56 / R57
Citroen: C2 / C3 / C4 / C5 / Grand Picasso Berlingo (MK3)
Xsara Picasso
Peugeot: 206 / 206cc / 207 / 207cc / 1007 / 307 / 308 / 308cc / 3008 / 5008 / Partner (MK3)

Attrezzo mantenimento in fase pulegge distribuzione

Tool for camshaft regulation



215 135

Motor/Engine VW 1.4 16V - 1.6 16V

Attrezzo blocco albero a camme per fase motori Audi A3 e Golf IV

Wrench for block distribucion Audi A3 and Golf IV



215 136 Kit completo

Ricambi - Spare-parts

- 215 136 01 Staffa
- 215 139 03 Perno blocca puleggia

**Attrezzo blocco Albero a camme motori
Audi 5 cilindri TDI e furgoni VW LT**

Wrench to block camshaft Audi 5 cylinder TDI and VW LT



215 137

**Attrezzo blocco alberi a camme motori<
VW - Seat - koda V6 TDI**

Block camshaft tool for VW-Seat-Skoda V6 TDI motors



215 139 Kit Completo

Ricambi - Spare-parts

- 215 139 01 Particolare 1 - Coppia staffe
- 215 139 02 Particolare 2 - Perno blocco albero motore
- 215 139 03 Particolare 3 - Perno forato

**Kit montaggio organi distribuzione composto
da staffa bloccaggio doppio albero a camme
e perno per rilevamento P.M.S.**

Kit for camshaft regulation with tool for locking double camshaft and pin for checking T.D.C.



215 140 Kit completo - Renault Mot. 1.4-1.6-1.8-2.0 16V

Ricambi - Spare-parts

- 215 141 Perno di ricambio - Renault Mot. 1.4-1.6-1.8-2.0 16V
- 215 142 Staffa di ricambio - Renault Mot. 1.4-1.6-1.8-2.0 16V

Kit montaggio organi distribuzione Renault 16V

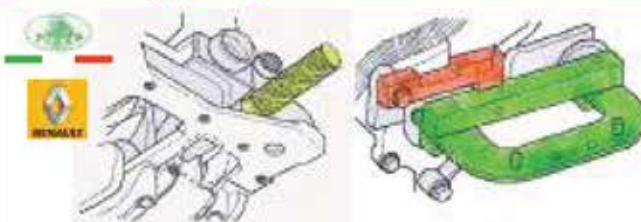

215 14000 Kit Motori 1.4 - 1.6 - 1.8 - 2.0 / 16V

Composizione - Composition

215 141  Perno per rilevamento PMS
(Utilizzabile anche per motori Diesel)

215 142  Staffa bloccaggio doppio albero
a camme

215 14201  Nuovo adattatore per staffa 215 142

Kit fasatura Renault 1,5 Dci

Engine camshaft Renault Dci



215 14005 In blister

**Perno corto per spazi ridotti per vecchi motori
Renault DCI 1.5**



215 141 01 In esaurimento

Kit fasatura distribuzione motori Renault 2.0 F5R

Timing tool set for Renault 2.0 F5R Model



215 14110

DIGITECH
ITALIA

Kit fasatura Renault, Opel, Nissan 1.8 / 2.0 16V

Engine camshaft sprocket locking device



215 14210 In valigetta

Dati tecnici - Informativa

Modelli:

Laguna 1.8 16V (2001 - 2005) con codice:
FP4, 722, 770, 721, 722, 773, 774, 775

Clio I (1994-2004), Clio III / sport (2006-2009),
Espace / Grand Espace (1998-2002) e G.E IV(2002-2010)
Laguna II 2.0 16V (2001-2007), Laguna III
Scenic(2007-2010)
Megane I (1999-2003), Megane II 2.0 16V (2002-2010),
Megane III (2008-2012)
Scenic (1999-2000), Scenic RX4 (1999-2003),
Grand Scenic II (2003-2009)
Traffic II (2001-2011)
Nissan primast X83 (2002-2011)
Opel Vivaro 2001-2011)

Codici motori:

F4R, 700, 701, 712, 713, 714, 715, 720, 732, 736, 738, 740,
741, 744, 746, 747, 760, 761, 762, 763, 764, 765, 766, 767,
770, 771, 774, 776, 784, 786, 787, 790, 792, 794, 795, 797, 830

Allineamento puleggia alberi a canne

Tool for camshaft regulation



215 143 Motor/Engine Renault - 1.4 - 1.6 16 V

DIGITECH
ITALIA

Attrezzo fasatura pompa iniezione motori Renault 1.9D

Kit check pumps injection motor Renault 1.9D



215 144 01

Motori Renault 1.9 D

Attrezzo bloccaggio ruota dentata pompa iniezione

Kit block cogwheel it pumps injection motor Renault 1.9D



215 14402

Motori Renault 1.9 D

Chiave ritegno ingranaggio pompa olio motori Renault Scenic - Clio e megane 1.6 - 8 valvole



215 14405

In sacchetto

Attrezzo blocca pompa iniezione Renault 1.9 TDI

Tool for Renault 1.9 TDI



Clio - Megane -
Laguna Kangoo



215 14410

In blister

Kit messa in fase motori Renault 2.2 Dci e 2.5 Dci

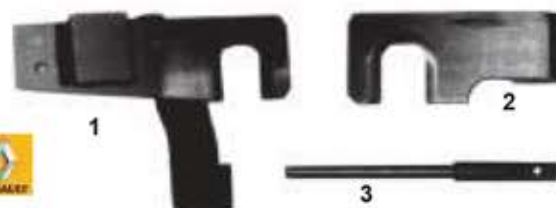

215 145

In valigetta

Ricambi - Spare-parts

- 215 145 01 Staffa Blocco cam aspirazione 1
- 215 145 02 Staffa Blocco cam scarico 2
- 215 145 03 Pemo blocco albero motore 3

Kit messa in fase motori Renault 2.2 Dci e 2.5 Dci

Kit for camshaft regulation Renault 2.2 Dci and 2.5



215 14510

In valigetta

Piastra allineamento puleggia alberi a camme motori Renault DCI 1.5 - 1.9

Tool to lock driving pulley while setting



215 146

In sacchetto

Kit messa in fase motori Renault

Timing tools Renault



215 14610

In valigetta

Dati tecnici - Informative

Twingo 1.2
R19 + Express + Extra + Rapid 1.4
Scenic 1.4/1-6/2-0 16V
Laguna 1.6 16V - 1.8+2.0 - 1.8+2.0 16V - 2.2D/TD - 2.5D/Td
Safrane 2.0 16V - 2.2 Td - 2.5 20V
Clio 1.2/1.4 - Clio 1-4/1.6/1.8/ 16V - Clio sport 2-0 16V
Master 2.5 D/Td
Trafic 2.5D -
Espace2.0 - 2.0 16V - 2.2Td

Piastra per fasatura alberi a camme montati su motori Renault e Nissan Qashqai 2.0 DCi

Camshaft timing plate 2.0 DCi Renault & Nissan



215 147

In valigetta

Ricambi - Spare parts



215 14701 Perno blocco albero motore



215 14702 Perno blocco ingranaggio
in 2 pezzi albero a camme aspirazione

215 14703



Piastra blocco puleggia

Piastra per fasatura alberi a camme montati su motori Renault e Nissan Qashqai 1.6 DCi

Tool to lock driving pulley while setting 1.6 DCi



215 14710

In valigetta

Ricambi - Spare parts

215 14711 Perno blocco albero motore



215 14712 Piastra blocco puleggia



Dati tecnici - Informative

Motore: R 9 M

Attrezzo estrazione pompa iniezione e mantenimento ingranaggio distribuzione motori Renault 2.2 e 2.5

Set for extraction and maintenance of distribution gear on engine Renault 2.2 & 2.5



215 148

Kit messa in fase motori G.M ecotech 2.0

Engine timing tool G.M



215 149

In valigetta

Kit montaggio distribuzione OPEL 2.0 TD 16V

Assembling tool for crankshaft OPEL 2.0 TD 16V



215 151

215 153

215 152

215 150

Kit completo in valigetta

Ricambi - Spare-parts

- 215 151 Piastra bloccaggio camme
- 215 152 Perno bloccaggio albero motore
- 215 153 Perno bloccaggio pompa iniezione

Kit messa in fase motori Diesel 1.7 Opel & Isuzu

Engine timing tools set Diesel 1.7 Opel & Isuzu



ISUZU



215 154 in valigetta

Kit messa in fase motori Opel 1.0 - 1.2 16V - 1.4 16V

Kit test distribuzione opel 1.0 - 1.2 16V - 1.4 16V motors



215 155 Kit Completo in valigetta

Ricambi - Spare-parts

- 215 155 01 Particolare 1 - staffa ruota fonica
- 215 155 02 Particolare 2 - perno blocco albero motore
- 215 155 03 Particolare 3 - Ø 2 mm - perno blocco tenditore
- 215 133 Particolare 4 - staffa blocco alberi a canne

DIGITECH
ITALIA

Kit fasatura motori Opel 1.0 / 1.2 / 1.4 con codice motore serie A, 3 & 4 cilindri



215 15510 Kit in valigetta

Adattatori opzionali - Optional



215 15501 Staffa aggiuntiva per motori serie "Z" Pz.1

Dati tecnici - Informative

Modelli:

Opel: Adam 1.2 / 1.4 - Ampera 1.4 - Astra J 1.4 - Aveo 1.2 / 1.4 Corsa D 1.0 / 1.2 / 1.4 - Insignia 1.4 - Meriva 1.4 - Mokka 1.4 Zafira 1.4 - Chevrolet Cruze 1.4

Codici motori:

A10XEP - A12XER - A12XEL - A14XER - A14NEL - A14NET - A14XEL - A14XFL
LCD - LDD - L2Z - L2Q - LWD - LUJ - LUH - 114 NET -

Kit messa in fase motori 2.2 16V

Petrol 2.2 16V (chain) Timing + Water pump tool set



215 156 Opel Astra - Vectra - Zafira - VX 220 - Signum

Kit fasatura cinghia distribuzione Opel Antara 2.0 CDTi e Chevrolet Captiva 2.0 VCDi

Timing belt f



215 157 In valigetta

Composizione - Composition

215 15701 Piastra bloccaggio alberi a camme

215 15702 Spina blocco albero motore

Kit fasatura motori EVO 2 - Motori 1,2 8V / 1,4 8V

Tool for camshaft regulation EVO 2 - 1,2 / 1,4 8V



Nuova staffa
215 15810

215 15800 Kit in valigetta con nuova staffa 215 15810

Composizione - Composition

215 15801 Staffa blocco albero motore con fori equidistanti

215 15810 Staffa blocco albero motore con fori disassati

215 15802 Staffa fasatura albero a camme

215 15803 Piastra posizionamento coperchio testata

215 15804 Staffa reazione puleggia distribuzione 1.4 8V

215 610 Chiave rotazione tenditore cinghia distribuzione

DIGITECH
ITALIA

Kit fasatura Opel Vauxhall 2.0 CDTi

Engine timing tool Opel Vauxhall 2.0 CDTi



215 169

In valigetta

Dati tecnici - Informativa

- A: Attrezzo di bloccaggio pignone pompa carburante ad alta pressione - OEM N° EN-51413
- B: Attezzo blocco tendicinghia trasmissione ausiliaria OEM N° EN-955-5
- C: Attrezzo blocco albero motore OEM N° EN-51412
- D: Perno blocco albero a camme OEM N° EN-51414
- E: Attrezzo per la tenuta della puleggia albero motore OEM N° EN 51-411
- F: Attrezzo allineamento alberi a camme OEM N° EN51415
- G: Perno ritegno tenditore OEM N° EN-51418

Opel Cascada 2015 - 2017

Opel Insigna, Insigna Country, Insigna Tourer 2017 - 2017

Opel Zafira C tourer 2014 - 2017

Piastra bloccaggio albero distribuzione



215 161

Opel 1.6 Diesel - Corsa - Kadett - Vectra

Piastra messa in fase albero distribuzione



215 163

Opel astra 1.7 D - Da utilizzare con 214 226

Kit fase motori AUDI AJM 115-130-150 CV

Tool for setting crunkshaft AUDI AJM 115-130-150 CV

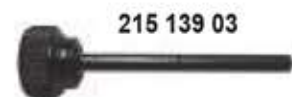

215 139 03



215 580

215 497



215 632 01

215 165

in valigetta

Kit messa in fase motori Audi / Skoda / Vw

Timing tool set for engine Audi / Skoda / Vw



215 166

Ricambi - Spare-parts



215 497

Staffa blocco albero motore 1.4 - 1.9 TDI



215 498

Staffa bolocco albero motore 2.0 TDI



215 498 01

Coppia di perni blocco puleggia distribuzione



215 498 02

Spine ritegno tendicinghia

215 580

Piastrina ritegno tendicinghia



215 632 01

Chiave tendicinghia

DIGITECH
ITALIA

Kit in valigetta fasatura motori VAG 2.4 / 2.5 Diesel

Engine timing tool set for VAG - 2.4 / 2.5 D



215 16670 Kit in valigetta

Dati tecnici - Informative

- A: Perno di bloccaggio della pompa
- B: Piastra regolazione dell'albero a camme
- C: Spessimetri (pz.2)
- D: Strumento puleggia tenuta albero motore
- E: Perno bloccaggio albero motore
- F: Tenditore

- VW 2.4 D AAB - AJA
- VW Crafter (06 - 12) 2.5 SDi AGX
- LT (96 - 06)
- Transporter (90 - 03) 2.5 TDi ACV - AHD - AHY -
- AJT - ANJ - APA - AUF - AVR - AXG - AXL
- AYC - AYY - BBE - BBF
- 2.5 TDiCR BJJ - BJK - BJL - BJM
- 2.5 Blue TDiCR: CEBA - CEBB - CECA - CECB

Kit messa in fase motori 2.0 TDI - Audi A4, A6 - Skoda Octavia - Vw Golf, Golf Plus, Jetta e Touran

Timing tool set for VAG 2.0 TDI



215 167 Kit in sacchetto

Ricambi - Spare-parts

- 215 497 Staffa blocco albero motore Vw 1.4 - 3 Cil 1.9 D - AJM
- 215 498 Staffa blocco albero motore 2.0 TDI
- 215 498 01 Coppia di perni blocco puleggia distribuzione
- 215 498 02 Spine ritegno tendicinghia

Kit in valigetta fasatura motori Audi 1.2 FTSI V8 turbo - Voksagen Polo 1.2 turbo - Skoda 1.1 - 1.6FSI, TSI

Petrol engine setting / locking kit VAG 1.2 - 1.4 - 1.6 FSI Chain drive



215 16810 Kit in valigetta

Ricambi - Spare parts

- 215 16811 Attrezzo blocco albero camme
- 215 16812 Perno blocco albero motore
- 215 16813 Attrezzo allineamento albero a camme

Dati tecnici - Informative

- Audi: A3 (03-10)
- Seat: Ibiza, Leon, Altea
- Skoda: Octavia (04-09), Fabia (07-09), Superb (09-10), Roomster (06-09),
- Volkswagen: Golf (03-09), Golf plus (05-09), Jetta (06-09), Passat (05-09), Polo (02-08), Scirocco (09-10), Tiguan (07-09), Touran (03-09), Eos (06-09)
- Codici motori: AXU, BLG, BAG, BMY, BKG, BMK, BLF, CAVA, BLN, CAVB, BLP, CAVC, CAVE, CAVF, CAVD, CAXA, CAXC, CDGA, CBZ, BTS

DIGITECH
ITALIA

Kit fasatura motori VAG 1.8 / 2.0 TSI/TFSI

Engine timing tool set for



215 16820

Kit in valigetta

Dati tecnici - Informative

1.8 R4 16V Tsi/Tfsi (EA888)

Audi TT Mk2 8J, Audi 8p A3, Audi B7 A4, Audi A4 B8, Audi A5

Seat Leon Mk2 1P, Seat altea XL

Skoda Yeti, Octavia Mk2 1Z Ming rui, Superb Mk2 3T

VW Jetta Mk5/Sagitar, VW Passat B6, VW Passat CC

2.0 R4 16V Tsi/Tfsi (EA888)

VW Golf Mk5 GTI & Mk6 (North american only)

VW Jetta Mk5, Jetta mk6, Passat B6, VW CC, Scirocco

Audi A3 8P, A3 cabrio, TT, TT Mk2, A4 B8, Q5, Q3

Skoda Superb Mk2 (3T), Octavia

Seat Altea freetrack, Leon FR, Exeo

Nel Kit:

utensile di spinta per albero motore, OEM T10368

- utensile di spinta per albero motore, OEM T10354

- 4 bulloni bloccaggio albero a camme, OEM T40196

- 2 clip bloccaggio tensionatore catena, OEM T40267

- 2 utensili bloccaggio pignone catena, OEM T40271

- utensile per regolazione valvole alberi a camme;

OEM T10352, OEM T10352/1, OEM T10352/2

- perno bloccaggio tensionatore, OEM T10060A

- 2 perni bloccaggio tensionatore, OEM T40011

- utensile bloccaggio pompa olio, OEM T40265

Kit messa in fase catena nella testata, Audi e Vw 2.0 FSI / TFSI

Petrol engine twin camshaft setting tool kit



215 169

Kit in valigetta

Audi: A3 2.0 FSI (03)

Audi: A4 2.0 TFSI (04)

Audi: A6 2.0 TFSI (06)

Vw: Golf, Touran 2.0 FSI (03), Passat 2.0 TFSI (05)

Kit fase VW VGA - 2.4D

Engine timing tools for Vw VGA - 2.4D



215 170

Dati tecnici - Informative

- Anno 02 / 1995 - 2003

Motori AAB - AJA

Kit messa in fase motori Vw 2.5 ad ingranaggi



215 17010

2.5 Tdi - PD

Kit in valigetta

Motori: AXD - AXE - BLJ - BNZ - BPC - BAC - BLK - BPD - BPE

Staffe blocco albero a camme

2 pcs timing locking tool



215 17011

Kit in valigetta

Motori: Phaeton / Touareg dal 2003 - Transporter dal 2004 2.5 Td, 5 e 10 cv

Kit montaggio alberi a camme per testata VAG / PORSCHE

Camshaft assembly kit for VAG / Porsche head



215 171 Kit testata In valigetta

Dati tecnici - Informative

- A:** Corpo
B: Morsetto di fissaggio albero a camme
C: Morsetto di allineamento dente ingranaggio
D: Morsetto di allineamento dente ingranaggio
E: Supporto albero a camme
F: Supporto albero a camme
G: Supporto albero a camme
H: Supporto albero a camme
I: Dispositivo bloccaggio supporto albero a camme

Codici motori:

- 1.2:** MCFWA
1.6: CAYA, CAYB, CAYD, CAYE, CLNA
2.0: CAAA, CAAB, CAAC, CAAD, CAAE, CAGA, CAGB, CAGC, CAHA, CAHB, CBAB, CBAC, CBBA, CBBB, CBDA, CBDB, CCHA, CCHB, CDBA, CDCA, CEGA, CFCA, CFFA, CFFB, CFFD, CFFE, CFGB, CFGC, CFGD, CFHA, CFHB, CFHC, CFHD, CFHE, CFHF, CFJA, CGLA, CGLB, CGLC, CGLD, CGLE, CJAA, CJCA, CJCB, CJCC, CJCD, CKTB, CKTC, CKUB, CKUC, CLCA, CLCB, CLJA, CLLA, CMEA, CMFA, CMFB, CMGB, CNEA, CNFA, CSHA
2.1: BPP, BSG, CAMA, CAMB, CANA, CANB, CANC, CAND, Cgka
3.0: ASB, BKN, BKS, BMK, BNG, BUG, BUN, CAPA, CARA, CASA, CASB, CASC, CASD, CATA, CCLA, CCMA, CCWA, CCWB, CDTA, CDTB, CDUC, CDUD, CDYA, CDYB, CDYC, CEXA, CGQB, CJGA, CJGC, CJGD, CJMA, CKVB, CKVC, CLAA, CLAB, CLZB, CMHA, CNRB, CRC, CRCA, M05/9D (CAS), M05/9E, M05/9E (CRCA), M05/9E (CRCB)
4.0: ASE
4.2: BRT, BVN, CCFA, CCFC, CDSB, CKDA

Marca	Modello	Telaio	Anno
Volkswagen	Golf plus	521 (09)	2009 / 2015
	Golf VI	5K1 (08/13)	2009 / 2013
	Golf VI Cabrio	517 (11)	2011 / 2015
	Golf VI Estate	AJ5 (09-13)	2009 / 2013
	Golf VI Estate	1K5 (07-09)	2009 / 2013
	Passat + alltrack	362/365 (11)	2011 / 2015
	Passat	3C2/3C5 (05-11)	2009 / 2011
	Passat CC	357	2008 / 2012
	Polo	6R109	2009 / 2015
	Scirocco	137 (08)	2008 / 2015
	Sharan	7N1 (10)	2010 / 2015
	Touran	1T1/1T2/1T3	2010 / 2015
	Caddy + Maxi	2Kx/2Cx (04)	2010 / 2015
	Crafter	2Ex/2Fx	2011 / 2015
	Transporter T5	7H/7J/7E/7F/ (04)	2009 / 2015
	Beetle	5C1/5C7 (11)	2011 / 2015
	CC	358	2012 / 2014
	Eos	1F7/1F8	2008 / 2015
	Jetta	162 (11)	2011 / 2015
	Jetta	1K2 (05/11)	2008 / 2011
	Tiguan	5N1/5N2	2007 / 2015
	Phaeton	3Dx	2004 / 2015
	Touareg	7P5	2010 / 2015

Audi	A5 Coupe/Cabrio	8f7/8t3	2007 / 2015
	A5 Sportback	8TA	2009 / 2015
	A6 + A6Quattro	4F2/4F5 (05-11)	2005 / 2011
	A6 + A6Quattro	4G2/4G5 (11)	2011 / 2015
	A6	4F2/4F5 (05-11)	2005 / 2011
	A6 Allroad	4FH (06-11)	2006 / 2011
	A6 Allroad	4Gh (12)	2012 / 2015
	Q3	8UB	2011 / 2015
	Q5	8RB	2008 / 2015
	TT	8J3/8J9 (06)	2008 / 2015
	A1	8XA/8X1	2010 / 2015
	A3	8PA/P1 (03-13)	2008 / 2013
	A3 Cabrio	8P7	2008 / 2013
	A4	8Ex (01-08)	2005 / 2008
	A4 Allroad	8KH	2009 / 2015
	A4 + A4 Quattro	8K2/8K5 (07)	2007 / 2015
	A4 Quattro	8EX (01-08)	2004 / 2008
	A4 Cabrio	8HE/8H7	2005 / 2009
	A8	4E2/4E8 (03-10)	2005 / 2010
	A8	4H2/4H8 (10)	2010 / 2015
	Q7	4LB	2007 / 2015
	A7	4GA	2010 / 2015
	AQ5	8RB	2013 / 2015

Porsche	Cayenne	92A	2011 / 2015
	Cayenne	9PA/948	2008 / 2010
	Panamera	970	2011 / 2015

Skoda	Fabia II	542/ 545 (07)	2010 / 2014
	Octavia II	1z3/1z5 (04-13)	2009 / 2013
	Praktik	5J7	2010 / 2015
	Rapid	NH3	2012 / 2015
	Roomster	5J7	2010 / 2015
	Suprb II	3T4/3T5 (08)	2008 / 2015
	Yeti	5L7	2009 / 2015

Seat	Altea + XL	5P1/5P5/5P8	2009 / 2015
	Exeo	3R2/3R5	2009 / 2013
	Leon	1P1 805-13	2009 / 2013
	Toledo	5P2 (04 - 09)	2009 / 2010
	Ibiza	6j1/6J5/6J8 (08)	2009 / 2015
	Alhabra	710 (10)	2010 / 2015

Kit fase motori Diesel VAG e rimozione/ installazione della pompa

Diesel engine setting/locking & Hp pump removal / installation kit



215 172 Kit in valigetta

Motori: VAG 2.7 / 3.0 Tdi V6 & 4.0 / 4.2 Tdi V8

Audi: A4, A5, A6, AB, Q5, Q7

Volkswagen: Tuareg, Phaeton

Codici motori:

ASB, BKN, BKS, BMK, BNG, BPP, BSG, BUG, BUN, CAMA, CAMB, CANA, CANB, CANC, CAND, CAPA, CARA, CARB, CASA, CASB, CASC, CATA, CCMA, CCWA, CCWB, CDYA, CEXA, CGKA, CGKB

Adattatore per albero a camme gruppo VAG

VAG camshaft adapter socket



215 173

Attacco 1/2"

Dati tecnici - Informativa

Questo adattatore è richiesto a causa del profilo modificato nel regolatore dell'albero a camme

OEM T10567

Indicato per VW Tiguan 2016 - Audi A4 2016

Perfetto per ruotare e bloccare il dispositivo di regolazione dell'albero a camme mentre si lavora sulla catena di distribuzione.

Per motori a 4 cilindri - 1.8 / 2.0 TFSI di 3a generazione.

OEM T40266

Indicato per i seguenti codici motore:

1.8 TFSI - CDAA - CDAB - CDHA - CDHB - CJSB - CJEB

2.0 TFSI - CNDC - CNDB - CDNC - CFKA - CPSA - CNCD

Utilizzabile sulle seguenti vetture:

VW - Beetle (13-16), CC (12-15), EOS (08-15), Golf V (03-09), Golf VI (09-13), Golf VII (12-15), Golf Alltrack (14-17), Jetta V (05-11), Jetta VI (11-16), Passat (11-17), Tiguan (07-15), Touran (14-17)

AUDI - A3 (12-16), A3 Sportback (12-16), A3 Cabriolet (13-16), A4 (08-15), A4 Quattro (12-15), A5 (09-11), A5 Sportback (09-16), A5 Cabriolet (09-12), Q5 (05-17), TT (15-17)

SKODA - Octavia II (08-13), Octavia III (13-17), Superb II (08-15), Superb III (15-17), Yeti (13-15)

SEAT - Alhambra (11-16), Altea (09-16), Altea XL (09-16), Altea FreeTrack (09-16), Exeo (09-16), Leon (09-17), Leon ST (13-17)

Kit messa in fase Land Rover - Jaguar

Land Rover / Jaguar engine timing tools kit



215 175

In valigetta

Dati tecnici - Informativa

Rover discovery 2.7TD V6 - Range Rover Sport 2.7TD V6
Jaguar TD V6

Kit fasatura Jaguar - Rover

Engine timing tools for Jaguar / Land Rover



215 177

In valigetta

Dati tecnici - Informativa

Jaguar:

XE 2015 - 2016, XF 2012 - 2015 GTDi, XJ 2013 - 2016 GTDi

Land Rover:

Discovery Sport 2015-2016, Si4, Freelander2 2012-2015 Si4

Range Rover:

Evoque 2011-2016 Si4

Codice motore: 204PT

OEM numbers: 303-1600, 303-1595, 303-1521, 303-1594, 303-748

DIGITECH
ITALIA

Kit messa in fase per motori Volvo e Land Rover Freelander II

Petrol engine setting Locking kit
Volvo & Land Rover Freelander II



215 181

In valigetta

Dati tecnici - Informative

Per motori:

S 80 (07 - 15)

XC60 (08 - 15)

XC70 (06 - 14)

XC90 (10 - 14)

Land Rover: Freelander II (11 - 14)

Codici:

3.0 Turbo: B6340T2, B6340T4

3.2: B6324S, B6324S5

3.2 I6: DW12CTED4/22DT

Particolari:

	OEM Volvo	OEM Land Rover
A:	999 - 7264	303 - 1226
B:	999 - 7263	303 - 1225
C:	999 - 7272	-----
D:	999 - 7257	303 - 1219
E:	999 - 7261	303 - 1223
F:	999 - 7266	-----
H:	999 - 7271	-----

Attrezzo per la tenuta dell'albero su motori a cinghia diesel / benzina Volvo

Diesel / Petrol crankshaft holding tool - Volvo -



215 183

Dati tecnici - Informative

Per motori:

C30 (06 -10), C70 (98-10), C70 (98-10), S40 (96-10), S60 (00-09)
S70 (97-07), S80 (98-06), V40 (96,10), V50 (04-10), V70 (97-07),
XC70 (02-07), XC90 (02-10)

Codici Diesel:

2.4D D5244T9, 2.4D D5244T8, D5244T13

Codici Benzina:

1.6 B4164S, 1.8 B4184S, 1.9T B4194T, 2.0 B4204S B4204T,
2.0T B5204T3 B5204T4 B5204T5, 2.3 B5234FS, 2.3T B5234T3
B5234T7 B5234T9, 2.4 B5244S B5244S2 B5244S4 B5244S5
B5244S7, 2.4T B5244T B5244T3 B5244T4 B5244T5 B5244T7,
2.5R B5254FS

Particolari: OEM 999 - 5433

Kit messa in fase Vw - Audi - Seat 1.8

Volkswagen timing tool



215 200

In blister

Dati tecnici - Informative

Audi: A3 - S3 - A4 - A6 - TT

Seat: Ibiza - Cordoba . Leon - Toledo - Alhambra

Skoda: Octavia

Vw: Golf - Bora - Beetle - Passat

Kit fasatura Volkswagen - Audi 1.0 - 1.2 - 1.4

Engine timing tool set



215 201 In valigetta

Dati tecnici - Informativa

Modelli:

Audi A3 e VW Golf dal 2013 1.2 - 1.4 ad iniezione diretta con 4 cilindri e turbocompressore Seat Mii, Skoda Citigo, Skoda Fabia III, VW Up, 1.0 con 3 cilindri

Codici motori:

CHYA, CHYB, CPGA,

Codici compatibili e utilizzabili come OEM:

T10340 / T10477 / T10476 / T10487 / T10494 / T10499

Kit bloccaggio / allineamento alberi a camme per Mercedes M 270, 1.6 / 2.0

Timing tool set Mercedes benz M 270



215 302 In valigetta

Dati tecnici - Informativa

Kit per regolare la fasatura del motore e il bloccaggio dell'albero a camme

Per motori:

270.910 / 270.920 / 274.910 / 274.920 / 133.980
Mercedes classe A (W 176 dal 2012), A 180, A 200
Mercedes classe B (W 246 dal 2011), B 180, B 200
Mercedes classe C ; C coupe, E, GLK
OEM 270589006100

Kit messa in fase per motori Mercedes M 271

Benz M 271 alignment tool kit



215 305 In valigetta

Dati tecnici - Informativa

Ideale durante la sostituzione della catena di distribuzione

Per motori:

C180, CLK 200K (W209), C200K, C230K (W203),
Csportcoupe C 160K, C 180K, C 200K, C 230K, E 200K (W211),
SLK 200K (R171), C 180K (W204), CLC 180K, CLC 200K,
C 180CGI, C 200CGI, C 250CGI (W204), E 200CGI (W212, C207)

Codici Motori:

DE18LA (09), E16ML (08), E18ML (02), DE18ML (05/05), M27

A = Punzone per tendicatena

B = Bussola TX 100 forata

C = Attrezzo bloccaggio catena distribuzione su albero a camme

D = Attrezzo bloccaggio albero a camme

DIGITECH
ITALIA

Kit messa in fase per motori Mercedes Z 3907

Benz Z 3907 alignment tool kit



215 308

In valigetta

Dati tecnici - Informative

Per motori:

Class 240/280 (202) (98-), C-Class 240/320 (203) (00-),
CL 500 (215) (99-07),
CLK 320/430 (208) (97-03),
CLK 240/320/500/55 AMG (209) (97-),
CLS 500/55 AMG (219) (05-), E-Class 240/280/320/430 (210)
(97-), E-Class 240/320/500/E55 AMG (211) (02-), M-Class
ML320/350/430/500/55
AMG (163) (98-), M-Class ML500 (164) (05-), S-Class
280/320/350/430/500 (220) (98-), SL 280/320/500
(129) (98-02), SL 350/500/55 AMG (230) (02-), SLK 320K (170)
(00-04), SLK 55 AMG (171) (04-),
R-Class 500 (05-), Viano 3.0/3.2/3.5 (03-), Vito (639) (03-)

Codici:

2.4 - 112.910 / 911
2.6 - 112.912 / 913 / 914 / 915 / 616 / 917
2.8 - 112.920 / 921 / 922 / 923
3.2 - 112.940 / 941 / 942 / 943 / 944 / 946 / 947 / 949 / 951 /
953 / 955
3.7 - 112.970 / 972 / 973 / 975 / 976
4.3 - 113.940 / 941 / 942 / 943 / 948
5.0 - 113.960 / 961 / 963 / 964 / 965 / 966 / 967 / 968 / 969 / 971
5.4 - 113.981 / 987 / 989 / 990 / 992 / 995

Particolari:

Particolari:	OEM
A:	112589003200
B:	112589012200
C:	112589000100

Kit messa in fase per motori Mercedes M 651

Benz M 651 timing tools kit



215 310

215 311

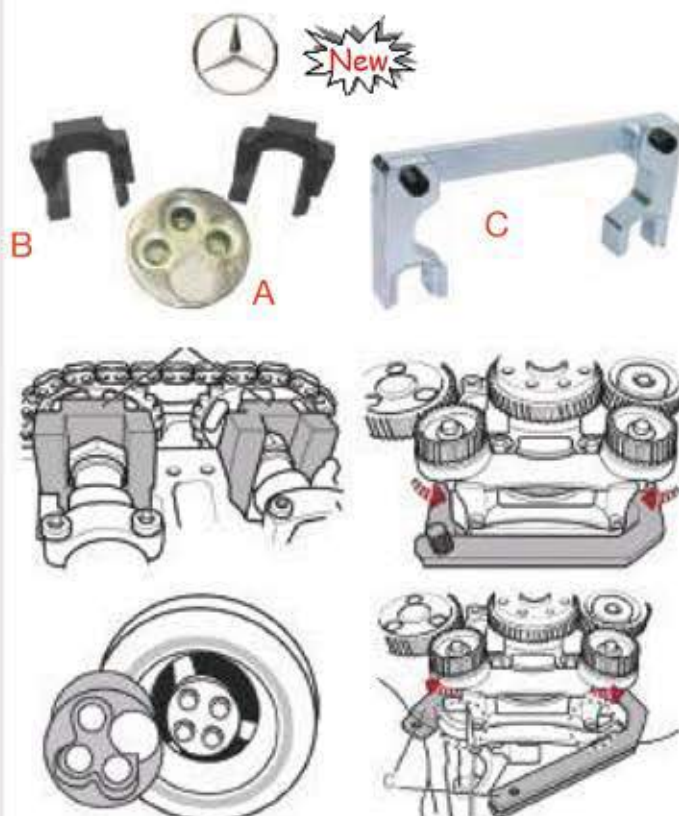

215 310

Senza staffa C

In valigetta

215 311

Completo di staffa C

In valigetta

Dati tecnici - Informative

OEM:

A= 651 589 01 40 00 / B= 651 589 00 40 00 - C= 651 589 02 63 00
Classe A W176 - 180/200/220 CDI / Classe B W246 - 200/220 CDI
Classe C W/S/C - 204/180/200/220/250 CSI
Classe C W205 - 220/250
Classe E - WS 212 200/220/250 CDI
Classe E - C/A 207 220/250 CDI
Classe E - W212 250/300 Blue tec / ML W166 250
SLK R172 250 CDI
Sprinter W906 210/213/310/313 CDI
W906 513/216/316/416/516 CDI
CLA C117 - 200/220 CDI - CLS C/X - 218 220/250
GLA X156 200/220 CDI - GLK X 204 200/220/250 CDI
Viano W/V 639 2.0/2.2 CDI - Vito W/V 639 110/113/116 CDI
Jeep Compass & Patriot dal 2012 al 2015
Dodge Caliber dal 2009 al 2011

Kit messa in fase per motori Mercedes M276, M157, M278

Benz M276 timing tool kit



215 312

In valigetta

Dati tecnici - Informativa

Per motori:

C 350 (W/S/C 204) DAL 2011
C 350/500/63 AMG (W/V221) DAL 2010
C 400 (W205) DAL 2014
CL 500/63 AMG (C216) 2010 / 2013
CLS 300 (218) DAL 2012
CLS 350/400/500/63 AMG (C/X218) 2011-2014
E 300/350/400 (C/A207) DAL 2011
E 300/350/400/500/63 AMG (W/S212) DAL 2011
E 400 Hybrid (W212) DAL 2012
G 63 AMG (W463) DAL 2012
GL 450/500 (X 166) DAL 2012
GLK 350 (X 204) DAL 2011
S 500 / 63 AMG (C 217) DAL 2014
ML 300/350/500/63 AMG (W166) DAL 2011
R 350 Blue Efficient (W/V 251) DAL 2012
SLK 350 (R172) DAL 2011
SL 350/400/500/63 AMG (R231) DAL 2012
S500 Ibrida plug-in DAL 2014
S 400/63 AMG (W/V 222) DAL 2013

Kit in valigetta fasatura distribuzione per una larga gamma di motori Mercedes sia diesel che benzina e motori Chrysler 2.2 CRD e 2.7 CRD

Timing tool set for Mercedes and Chrysler 2.2 / 2.7



215 470

Kit fasatura distribuzione per motori Audi 100 e A6 con motore Z15L TDI e VW Polo Diesel.

Timing tool set for Audi 100 and A6 Z15L motor - VW Polo Diesel



215 474

In valigetta

Kit installazione / rimozione molle valvole

Installer / remover valve pressure spring



215 475

BMW - Mini N-18

Euro 383,200

DIGITECH
ITALIA

Kit messa in fase motori BMW 1.6 (N13 & N18)

BMW timing tool set (N13 & N18)



215 476

Kit in valigetta

Dati tecnici - Informative

- A: Attrezzo allineamento cam scarico
- A: Attrezzo allineamento cam aspirazione
- B: Attrezzo pretensionamento catena
- C: Perno volano
- D: Perno volano

Modelli:

Mini Cooper S (R56/57) (10-15), Coupe cooper S (R58) (12-15) Countryman (R60) (12-14), Paceman (R61) m(13-15)

Codici motori:

N13 B16A, N18 B16A/M0

Kit fasatura motori Bmw-Mini / Citroen / Peugeot

Petrol engine twin camshaft setting/locking tool



215 477

In valigetta

- BMW MINI - CITROEN - PEUGEOT (1.4 / 1.6 16V valvetronic)
- Bmw mini: R55 - R56 COOPER S
- Bmw mini: R55 - R56 COOPER
- Bmw mini: R56 MINI ONE
- Citroen: C4 - C4 Picasso
- Peugeot: 207 - 308
- Bmw: N12 (1.4 - 1.6)
- Bmw: N14 (1.6)
- PSA: EP3 - EP6 - EP6DT - DTS

Kit fasatura distribuzione per BMW Mini

EngineTiming Tool Kit for BMW Mini



Per motori:
8 Valvole

215 478

In valigetta

Dati tecnici - Informative

- Anno 2001-06 Mini cooper W10B16AA
- Anno 2001-06 Mini cooper S W10B16BA
- Anno 2002-06 W11B16AA

Kit fasatura distribuzione per BMW Mini One

EngineTiming Tool Kit for BMW Mini One



Per motori:
8 / 16 Valvole

215 479

In valigetta

Dati tecnici - Informative

- Anno 2001-06 Mini One W10B16AA
- Anno 2001-06 Mini cooper W10B16BA
- Anno 2002-06 Mini Cooper W11B16AA
- Motore N 14

kit universale estrazione pulegge - Poly V

Universal pulley puller set



215 480

In valigetta

Blocca puleggie universal

2 Way universal timing belt locking tool



215 484

In valigetta

Attrezzo universale bloccaggio pulegge distribuzione con 4 settori dentati orientabili.

Universal tool for block camshaft wheel.

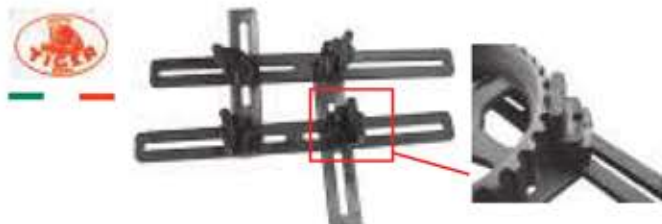

215 485

Kit composto da 4 staffe corte e 2 lunghe

Kit estrazione pulegge VW Audi



215 486

Per motori Audi - Vw - 4 e 6 cilindri

Estrattore pulegge con 8 fori a losanga per viti M8 & M10

Extractor pulleys with 8 holes for M8 & M10 screw



215 487

Ø100 - utilizzabile con 3, 4 o 6 viti Ford Fiesta

Estrattore puleggia albero motore Ford Focus

Extractor for Ford Focus camshaft pulley



215 488

Ø 80 con 4 piedini

Attrezzo bloccaggio volano motore Ford



215 48910

In blister

Ricambi - Spare parts

215 48911

Piastra

215 48912

Staffa corta

215 48913

Staffa lunga

Kit attrezzi bloccaggio pulegge distribuzione motori

Driving pulley retainer tool kit



215 490

Kit in blister

Composizione / Composition

215 490 01 Giallo/Yellow/Amarillio - OPEL 16V 1800/2000

215 490 02 Blu - OPEL 16V 1400/1600

215 490 03 Verde/Green/Vierde - OPEL V6 2500/3000

215 490 04 Rosso/Red/Roco - OPEL V6 2500/3000

215 490 05 Grigio/Gray/Gris - SAAB - 900/900 0

215 490 06 Nero/Black/Negro - ROVER - Tipo K16

Attrezzo blocco pulegge alberi a camme - 1.8 - 16V



Con riferimento marcato
al laser per facilitarne l'utilizzo

215 491

Kit attrezzi bloccaggio pulegge e volano su motori Opel - Saab - Rover - Isuzu - VW



215 492

In valigetta

Staffa blocco albero motore VW 1.4 TDI - 1.9 TDI

Stirrup block camshaft VW 1.4 TDI - 1.9 TDI



215 497

Vedi Kit 215 165 / 215 166 / 215 167

Staffa blocco albero motore 2.0 TDI



215 498

Coppia perni blocco tenditori cinghia distribuzione



215 49802

Attrezzo per fermo puleggia albero motore

Tool for retaining crankshaft pulley



215 501

Alfa 164 2,5 TD

Attrezzo per fermo albero distribuzione durante smontaggio albero motore

Tool for retaining crankshaft during dismounting



215 502

Audi 5 cil. da usare/use with/con 215 520

Attrezzo per fermo albero distribuzione durante smontaggio albero motore

Tool for retaining crankshaft during dismounting



215 503

Audi 6 cil. da usare/use with/con 215 520

Attrezzo per fermo albero distribuzione durante smontaggio albero motore

Tool for retaining crankshaft during dismounting



215 504

Audi 6 cil.mot. WOS da usare conr/use with/
con 215 524

Chiave tensionamento puleggia organi ausiliari

Wrench for tensioning auxiliary



215 510 Marea-Marea week end 2400 D - 32 mm

Chiave smontaggio puleggia albero motore BMW con dump (antivibrazione)

BMW key crankshaft pulley removal with dump



	A	B	C
	Ø est.	Ø int.	Dente
215 515	63,5	57,3	15
215 516	68,5	57,5	15

Chiave dado fissaggio puleggia albero motore

Wrench for nut fixing pulley on crankshaft



- 215 520 Audi - 27 mm
- 215 521 Uno 60/70/turbo ie-Ritmo 60/ES/70/85-Regata 70/ES/-75/85 - 30 mm
- 215 522 Fiat 126-900T-Panda 30-Punto 1108/1242 SPI/ MPI - 32 mm
- 215 523 Fiat 124 Spider-125 - 34 mm
- 215 524 Audi mot. 6cil-127-Panda 45-131 D- Punto 1372 Turbo - 36 mm
- 215 525 127 - 1050 - 128 - Ritmo - 131B - 132B - Campagnola - Ritmo - D-Uno 60/70 Turbo ie Regata 70ES/75/85 - 38 mm

Chiave dado fissaggio puleggia albero motore

Wrench for nut fixing pulley on crankshaft



215 530 Alfa sud-Arna-33 - 27 mm

Chiave dado fissaggio puleggia albero motore

Wrench for nut fixing pulley on crankshaft



215 540 Kappa - 19 mm

Attrezzo per smontaggio pulegge multigola poliv

Pulley removing wrench



215 543 In blister
215 54301 Fascia di ricambio

Attrezzo bloccaggio puleggia trapezoidali

Tool locking pulley



215 544 In blister

Attrezzo bloccaggio puleggia distribuzione

Tool locking camshaft pulley



215 545 Alfa Sud-33

Attrezzo rotazione organi distribuzione motori con 4 perni riposizionabili

215 548



Kit completo per flange rotazione motori Fiat

Universal tool locking camshaft pulley



Supporto
215 549



Flangia 215 550

Flangia 215 551

Flangia 215 552



Flangia 215 553

Flangia 215 554



215 555 Kit completo in valigetta

Ricambi - Spare-parts

215 549 Supporto

215 550 Flangia Lancia Kappa- 164 24 V - Multipla Bipower

215 551 Flangia Bravo - Brava - 145 - 146

215 552 Flangia Coupè - Barchetta - 146 2000 cc

215 553 Flangia Marea Week-end 1910-2400cc

215 554 Flangia rotazione puleggia distribuzione motori Multijet

Attrezzo rotazione puleggia Multijet 1.3



215 557

Dati tecnici - Informative

Utensile a 5 perni per il ritegno della nuova puleggia che agisce sulla catena di distribuzione dei motori Fiat 1.3 MJT

- consente di bloccare la puleggia durante le operazioni di regolazione/montaggio/smontaggio della catena di distribuzione
- assicura un corretto serraggio sfruttando cinque degli otto fori della puleggia
- lunghezza 270 mm

Attrezzo rotazione organi distribuzione motori, con 4 serie di perni intercambiabili per Ford e Vag

Key rotation distribution Ford & VAG motors



Nuovo modello sostitutivo di Pag.105



mm 495



Perni maschio



Perni fresati



215 558 Con 1 serie di perni fresati Ø 17

215 559 Con 4 serie di perni

Ricambi - Spare parts

215 55817 Coppia perni fresati Ø 17

215 55906 Coppia perni maschio Ø 06

215 55908 Coppia perni maschio Ø 08

215 55910 Coppia perni maschio Ø 10

Attrezzo rotazione organi distribuzione motori NISSAN - TOYOTA

Key rotation distribution NISSAN - TOYOTA Motor



215 560

Attrezzo rotazione organi distribuzione motori TOYOTA e LEXUS

Key rotation distribution LEXUS - TOYOTA Motor



215 562

Attrezzo per tensionamento cinghia dentata comando distribuzione

Devices for tension of toothed timing belt



215 570 Bravo - Brava 1.6 16V

215 571 Fiat Multipla Bipower - Fiat Stilo

Ricambi - Spare parts

215 57001 Perno filettato mm 8 x 1,25

215 57101 Perno filettato mm 10 x 1,25

Attrezzo tendicinghia femmina per motori Alfa Romeo

Tool female for timing belt tension



215 572 Alfa Romeo

Attrezzo tendicinghia maschio per motori Alfa Romeo

Tool male for timing belt tension



215 573 Alfa Romeo

Attrezzo tendicinghia motori Renault Megane

Tool for timing belt tension



215 574 Renault Megane

Chiave tensionamento cinghia Renault



215 575 Benzina - quadro mm 8x180

215 576 Diesel - quadro mm 9x200

Piastrina ritegno tendicinghia motori / VW AJM

Wrench for Block toothed timing belt VW AJM motor



215 580

Set chiavi smontaggio ventilatori VISCO

7 Pz Benz & Bmw fan service wrench kit



215 590 BMW - FORD - MERCEDES - OPEL

Chiavi smontaggio elettroventole BMW e AUDI

Fun clutch tools

Acciaio - Brunito



mm 400

215 590 32

Bocca mm 32

215 590 36

Bocca mm 36

Attrezzo magnetico universale per inserimento / rimozione cinghie elastiche

Stretch belt remover / installer



215 604 In sacchetto

Attrezzo universale professionale per inserimento e rimozione cinghie elastiche

Tool kit for elastic - ribbed belts



215 606

Kit in valigetta - Pz.5

Chiave tendicinghia

Timing tool Renault



Attrezzo ideale per lavori in posti stretti e facile da utilizzare grazie all'attacco da 3/8" con doppio quadro

215 609

Dati tecnici - Informative

Lunghezza mm 47 - Profondità mm 32,5

Attrezzo per rotazione tenditore cinghia distribuzione

Device for tension of timing belt



215 610

Nuova Punto Lancia Y - Mot.Eng.1200 cc 16v

Attrezzo per tensionamento cinghia dentata comando distribuzione

Device for tension of toothed timing belt



215 611

Uno 45-Fire-Tipo-Ritmo-Tempra-Regata-Croma - Thema ie/16 v Turbo-Punto -Alfa-155-164
Kit completo

Ricambi - Spare parts

215 612 Staffa tonda / Round staff / Recambio redondo

215 613 Perno / Pin / Recambio - 6-6 mm

215 614 Perno / Pin / Recambio - 6-8 mm

Attrezzo per tensionamento cinghia dentata comando distribuzione

Device for tension of toothed timing belt



215 616

Ritmo Diesel

Attrezzo per tensionamento cinghia

Device for tension of toothed timing belt



215 617

Perno per tensionamento cinghia dentata comando distribuzione

Device for tension of toothed timing belt



215 618

Fiat Ulisse

Attrezzo rotazione albero motore Mercedes A112 - A123

Flywheel rotation tool Mercedes A112 - A123



215 619

L= mm 700

Attrezzo fermo puleggia dentata organi ausiliari

Device for locking service belt



215 621

127-Uno 60/70/Turbo-Ritmo 60/es/70/85-Regata 60/ - S/70/85

Attrezzo fermo puleggia dentata organi ausiliari

Device for locking service belt



215 622 127 1050-Rustica-Ritmo 60

Attrezzo montaggio smontaggio tendicinghia

Device for dismounting timing belt turnbuckle



215 624 Bravo 1998 20v-Kappa Motor Vis

Bussola femmina per vite puleggia albero motore Toyota 1ZZ-FE

1/2" 10S size: 1/2"DR X 10S, HEX21mm



	A	B	C	Att.
215 625	32	10S	Esagono mm 21	1/2"

Chiave tendicinghia Motori Audi

Wrench for tension tothed belt



215 626 mm 46

Bussola femmina per viti testate e vite centrale puleggia albero motore Nissan



	A	B	Att.
215 627	38	12S	1/2"

Chiave tendicinghia Motori Ford

Wrench for tension tothed belt



215 628

Chiave per pulegge e organi ausiliari

Benz fan belt service wrench



215 629

Dati tecnici - Informativi

Strumento universale ideato per Mercedes e Nissan. L'attacco maschio quadro 1/2" da un lato, l'esagono porta inserti da 8mm (5/16") dall'altro, disegnati su di una barra stretta, lunga, piatta e molto resistente permette di lavorare in più zone con accesso confinato

Chiave manovra semipuleggia tensionamento cinghia comando pompa acqua

Wrench for water pump belt



215 630 Cromax D/TD

Chiave manovra semipuleggia tensionamento cinghia comando compressore condizionamento

Wrench for air conditioned compressor belt



215 631 Cromax D/TD

Chiave tendicinghia

Wrench for tension tothed belt



215 632 Golf 1600- Golf TD
215 632 01 Lunga per motori AJM-115-130-150 CV

Pratico tendicinghia regolabile

Timing belt extension tool



215 63210 Con attacco quadro 1/4" In blister
215 63211 Con attacco esagonale 10 mm In blister

Dati tecnici - Informative

2 Spine: Ø 3
Apertura min: mm 8 - max: mm 25

Kit chiave tendicinghia con innesti intercambiabili Torx e Poligonali

15 Pcs changeable pulley wrench



215 633 In valigetta pz.15

Composizione - Composition

Chiave con testa ad innesto.
Innesti Torx: E10 - E12 - E14 - E16 - 18
Innesti Poligonali: 12 - 13 - 14 - 15 - 16 - 17 - 18 - 19 mm

Set 5 Pz chiavi poligonali piatte, sottili, lunghe, per rotazione pulegge distribuzione, organi ausiliari e tendicinghia

5 Pcs polygonal wrench set, long and flat, for pulley and tension tothed



215 634 mm 13 - 15 - 16 - 17 - 19

Ricambi - Spare parts

215 634 12	Non inclusa nel set - mm 12
215 634 13	mm 13
215 634 14	Non inclusa nel set - mm 14
215 634 15	mm 15
215 634 16	mm 16
215 634 17	mm 17
215 634 18	Non inclusa nel set - mm 18
215 634 19	mm 19

Attrezzo per posizionamento piastrina porta sensore

Devices for little plate positioning side camshaft



215 635 Ritmo ES

Calibro controllo posizionamento tendicinghia distribuzione

Gauge control positioning of toothed timing belt turnbuckle



215 636 127 D

Attrezzo ritegno supporto centrale per smontaggio albero distribuzione

Tool retainment central engine support during replacement and installation of camshaft

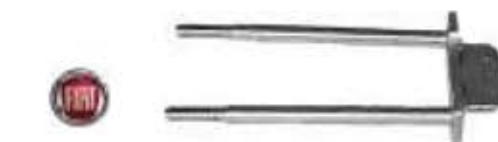

215 637 127 D

Chiave serraggio tendicinghia Motori Renault Benzina

Wrench for tension toothed belt Renault engine gasoline



215 638

Set chiavi poligonali piatte - sottili - con occhiello rinforzato, per pulegge distribuzione, organi ausiliari e tendicinghia

5 pcs damper pulley luller set



215 639 mm 13 - 15 - 16 - 17 - 19 - Valigetta Pz 5

mm 470



Ricambi - Spare-parts

- 215 639 13 Chiave singola mm13
- 215 639 15 Chiave singola mm15
- 215 639 16 Chiave singola mm16
- 215 639 17 Chiave singola mm17
- 215 639 19 Chiave singola mm19

Note:

DIGITECH
ITALIA

Set chiavi poligonali lunghe piatte con anello alto e sottile, ideale in officina per pulegge ed organi di servizio

Extra long off set box polygonal wrench set

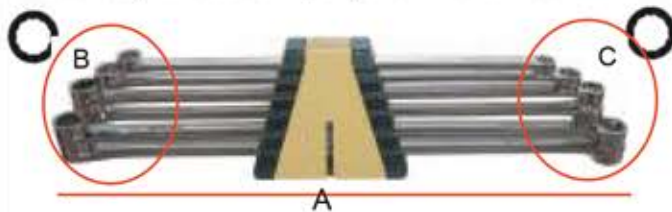

215 640

Kit 6 Pz

Ricambi - Spare-parts

	A	B	C
215 640 10	mm 290	mm 10	mm 12
215 640 12	mm 360	mm 12	mm 14
215 640 13	mm 360	mm 13	mm 15
215 640 14	mm 400	mm 14	mm 17
215 640 16	mm 400	mm 16	mm 18
215 640 17	mm 400	mm 17	mm 19

Adattatori opzionali - Optional adaptor

- 215 64021 Non inclusa nel set mm 450 mm 21 mm 23
- 215 64022 Non inclusa nel set mm 450 mm 22 mm 24

Set chiavi Torx piatte, sottili, con occhiello rinforzato, per tendicinghia e organi ausiliari

5 pcs damper pulley puller holder wrench set



215 641 E10 - E12 - E14 - E16 - E18

Chiave di smontaggio per pulegge albero motore

Reaction wrench for crankshaft pulley



215 643 In valigetta

Dati tecnici - Informative

- Per Vw Audi 4 & 5 cilindri con e senza l'ammortizzatore armonico
- Ideale per la sostituzione cinghia di distribuzione
- Utilizzabile anche da un singolo meccanico

Note:

Chiave a battere da 1/2" per viti pulegge

Hand impact wrench for pulley 1/2"



mm 570

215 645

Attrezzo blocco alberi a camme su Multijet 1.3

Key rotation Multijet 1.3



Denti Denti Lunghezza
215 646 mm 7 x 11 mm 9 x 7 mm 530

Estrattore puleggia trascinamento albero distribuzione

Extractor for delivery driving pulley



215 650 Bravo-Brava-Punto-Tempra-145-146-
Barchetta - Coupè-Lancia-Kappa-Ulisse

Estrattore registrabile per puleggia trascinamento pompa iniezione

Adjustable extractor for delivery driving pulley



215 651 2 zampe / 2 Legs / 2 patas - Ø 46-86 mm

Ricambi - Spare parts

215 653 zampa / Leg / pata
215 654 zampa / Leg / pata

Estrattore registrabile per pulegge trascinamento pompe iniezione

Adjustable extractor for delivery driving pulley



215 652 3 zampe / 3 Legs / 3 patas - Ø 46-86 mm

Ricambi - Spare parts

215 653 zampa / Leg / pata
215 654 zampa / Leg / pata

Estrattore puleggia trascinamento albero distribuzione

Extractor for delivery driving pulley



215 656 Peugeot-Passat

DIGITECH
ITALIA

Estrattore estensibile per pulegge Poly V

Puller for ribbed pulleys



215 658

Estrattore puleggia trascinamento albero distribuzione

Extractor for delivery driving pulley



215 660 Uno turbo D

Chiave per puleggia albero motore Honda CR-V

Crank shaft Pulley or Honda CR-V. Esagono 50 mm



215 661

Dati tecnici - Informative

Specifica per facilitare la rimozione e l'installazione delle pulegge Honda con esagono 50 mm sottile
Attacco 1/2" per l'utilizzo di un'asta con quadro o di un cricchetto Honda
CR-V 2.0L 4cyl 97-01. 4cyl 2.4L 02-16
elemento 2.4L 4cyl 03-16
preludio 2.2L 4cyl 92-01. 4cyl 2.3L 92-96
Acura 2.2L 4cyl 90-97. 2.7 l 6cyl 96. 2.3 l 4cyl 98-02. 2.4 l 4cyl 03-16. 3.0 L V6 98-16
Civic 1.6 l 4cyl 92-00. 1.7 l 4cyl 01-2016. 2.0 l 4cyl 03-piA¹ recente pilot 3.5 L V6 03-16
ridgeline 3.5 L V6 06-16
intuizione 1.0 l 3cyl allmodel
s2000 2.0 l 4cyl 00-03. 2.2 l 4cyl 04-16
cl 2.2 l 4cyl 97. 2.3 l 4cyl 98-99. 3.0 l 4cyl 98-16
rl 3.5 L V6 96-16
Odyssey 2.2L 4cyl 95-97. 4cyl 2.3L 98. 3.5L V6 99-16
Delsol 4cyl 93-97
Integra 1.6L 4cyl 90-92. 4cyl 1.7L 92-93. 93-01 1.8L 4cyl
TL 3.2 L V6 95-16
NSX 3.0 L V6 91-16 (non va bene per tutti i motori). 3.2 l V6 98-16

Attrezzo a 3 zampe per estrazione pulegge a 3,6,9 fori diametro regolabile da 42 - 82 mm

Timing pulley puller



215 662 Estrattore a 3 zampe con profondità 28,8 mm

Adattatori opzionali - Optional adaptor

215 66249  3 zampe prolungate profondità 49 mm

Estrattore pulegge con zampe orientabili

Extractor pulleys with adjustable legs



215 664 FIAT - ALFA ROMEO - LANCIA

Estrattore puleggia trascinamento albero distribuzione

Extractor for delivery driving pulley



215 665 127 D

Estrattore pompa iniezione per posizionamento ingranaggio

Extractor for injection pump



215 671 Alfa 90 Bosch

Estrattore girante pompa iniezione

Extractor for turbine injection pump



215 673 Alfa 75-33 Bosch

Estrattore puleggia trascinamento elettro ventilatore

Extractor for fan coil driving pulley



215 675 Alfa 164 TD

Introduttore corteco albero distribuzione lato aspirazione

Oli seal camshaft introducer



215 678 145-146-Spider Alfa-Bravo-Brava-Coupè



Chiave per smontaggio alternatori

Wrench for alternator disassembly



215 679 Alfa 159 - Fiat Nuova Croma

Chiave per lo smontaggio e montaggio alternatori

Alternator wrench



mm 90

215 681 Fiat Bravo. Grande Punto

Kit inserti per alternatore

Alternator bits



215 682 Pz 5

Ricambi - Spare parts

215 68201	Inserto esagonale per alternatore	8 x 120
215 68202	Inserto esagonale per alternatore	10 x 120
215 68203	Inserto XZN per alternatore	M 8 x 120
215 68204	Inserto XZN per alternatore	M 10 x 120
215 68205	Inserto Torx per alternatore	T50 x 120

Chiave per smontaggio puleggia alternatori Per Mercedes classe A

Alternator wrench



215 683 Tx 50 + chiave multident

Composizione - Composition

215 68301 Bussola Tx 50 x 110 mm con inserto tondo

215 685 Chiave multi denti corta

Chiave per smontaggio puleggia alternatori Valeo

Alternator wrench



215 684 Xzn 10 + Esagono 28

Composizione - Composition

215 68400 Bussola Xzn 10 x 110 mm con inserto tondo

215 68401 Esagono mm 28

Chiave per lo smontaggio alternatori Valeo

Alternator wrench - Valeo



mm 110

215 684 02

Renault

Chiave smonta alternatori VAG - MB - Bmw

Alternator wrench



215 684 03

XZN M10

Chiave multi denti per puleggia alternatore bosch

Tool for alternator pulley dismounting



215 685



mm 50

215 686



mm 30

215 685

Audi - Volkswagen

215 686

Fiat

Chiave per lo smontaggio alternatori

Alternator wrench



mm 100

215 686 01

Dati tecnici - Informative

*Nata per la Nuova Alfa Mito è indicata per tutti i motori Fiat - Alfa - Lancia, dal 2007 in poi.

Ricambi - Spare parts



215 686 11

Chiave alternatori
Fiat - Alfa - Lancia dal 2007 in poi

Chiave multidenti per puleggia Mito

Alternator wrench for Mito



215 68612

Kit per lo smontaggio della puleggia alternatori Bosch - Marelli

8 pcs pulley remover kit



215 687

Pz.8

In blister

Composizione - Composition

215 68201 Inserto Esagonale per alternatore 8 x 120

215 68202 Inserto Esagonale per alternatore 10 x 120

215 68203 Inserto XZN per alternatore M 8 x 120

215 68204 Inserto XZN per alternatore M 10 x 120

215 68205 Inserto Torx per alternatore T. 50 x 120

215 686 Chiave multi denti corta

215 689 Chiave a 4 denti per dado puleggia

411 756 Bussola porta inserti Es.F 10 x 1/2"

Kit per alternatori Bosch - Marelli - Valeo

16 Pcs V-belt pulley remover bit socket set



215 68816

16Pz

In valigetta

Kit per alternatori Bosch - Marelli - Valeo

22 Pcs V-belt pulley remover bit socket set



215 68822

22Pz

In valigetta

Novità: Nel set è inclusa la nuova chiave a 3 denti per alternatori Toyota - Mini + la nuova chiave a 33 denti per Citroen - Peugeot

Kit smontaggio puleggia alternatori Bosch - Marelli - Valeo

23 pcs V-belt pulley remover bit socket set



215 688 23 Pz 23

Nel set sono incluse le nuove chiavi per:
- Chiave per Opel Denso
- Chiave a 3 denti per Toyota e Mini
- Chiave a 33 denti per Citroen e Peugeot

Chiave a 4 denti per dado puleggia alternatori Marelli

Tool for alternator pulley dismounting - Marelli



215 689

Leva tensionamento cinghia servizi quadro mm 7- 8

Tool for service belt



215 690 Lancia Z Td - Ulisse TD-peugeot 806 Citroen Evasion -160 mm

Adattatore per alternatori Opel / Denso

Alternator wrench Opel / Denso



215 691

Chiave a 3 denti con esagono di manovra per lo smontaggio alternatori Nippodenso Toyota - Mini



215 692

Chiave a 3 denti con manico di manovra per lo smontaggio alternatori Nippodenso Toyota - Mini

Alternator wrench Nippodenso - Toyota - Rover



Utilizzabile con bussola
esagonale mm 10 -
art.414 131
(non inclusa)

mm 190

215 69201

Chiave singola

Chiave per lo smontaggio alternatori Opel - Denso

Alternator wrench -



Att. 1/2"

215 693

Pinza acciaccatura terminali cavi acceleratore

Wire crimping plier



215 800

Per terminali cavi

DIGITECH
ITALIA

Pinza fascette manicotti bifilari piatte

Spring clip pliers



Cromate -
Isolate



mm 215



mm 280

215 81010

mm 215

215 81011

mm 280

Pinza per fascette manicotti con impugnatura a pistola ed albero flessibile di 600 mm

Universal hose clamp removal



215 811

Pinza

Pinza per fascette manicotti con albero flessibile

Plier for manifold band with articulation



215 81201

In blister

Ricambi - Spare parts



215 81202

Filo di ricambio

215 81205

Filo + Guaina + Slitta

Cavo completo di pinza per ricambio

Spare kit

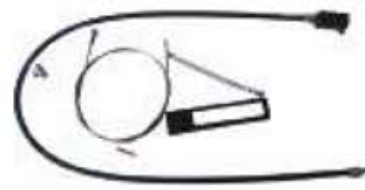

215 81204 Filo-Guaina-Slitta per 215 812 In esaurimento

215 81205 Filo-Guaina-Slitta per 215 81201

215 81206 Filo-Slitta per 215 81203 In esaurimento

Pinza per fascette con albero flessibile

"F" type spring clamp pliers



215 81220

In blister

Ricambi - Spare parts



215 81221

Ricambio

Pinza per fascette manicotti a filo tondo

Hose clamp pliers



215 813

mm 210

Pinza per fascette manicotti con banda piatta larga

Hose clamp pliers



215 814

mm 210

Pinza per fascette manicotti con banda piatta

Plier for manifold band



215 815

mm 200

Pinza per fascette manicotto a banda larga

Sleeves plier



215 816

Piegata 30°

Pinza per lo smontaggio fascette manicotti dei motori 2.0 TDi VW - Audi

Plier for manifold band



mm 235

Placca mm 16 con tacche di appoggio della fascetta mm 5



mm 300

Placca mm 20 con tacche di appoggio della fascetta mm 7



Albero flessibile mm 700

mm 250

Placca mm 20 con tacche di appoggio della fascetta mm 7

215 817

Pinza mm 235

215 818

Pinza mm 300

215 819

Con albero flessibile - Pinza mm 250

215 819 01

Filo di ricambio

Pinza per fascette manicotti "Oetiker"

Boot clamp plier



mm 210

215 820

In blister

Note:

DiGITECH
ITALIA

Pinza per fascette ad orecchio frontale

Plier for front band

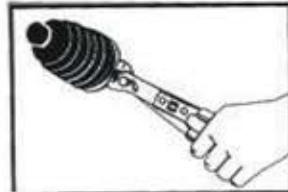
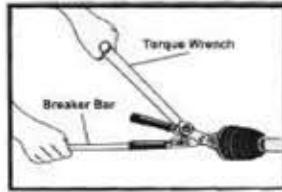

215 822

In blister

Pinza per fascette ad orecchio laterale

CV boot clamp plier



215 824

mm 240

VEDI ANCHE

Cuffie 223 105 Sez 4

Fascette 521 501 Sez 15



Tenditore di fascette utilizzabile con una mano

Hose clamp tensioner - one hand operation



Leva d'azione con singola mano

Anello per regolare la misura

Particolare denti progettati per bloccare bene la fascetta



Ideale per diversi tipi di fascette



215 825

In blister

Pinza per fascette tubi carburante VAG



215 830

Vw - Audi

195 mm

Pinza per fascette bifilari

Hose clip pliers



mm 28



mm 195

215 832

In blister

DIGITECH
ITALIA